

# RIEILE

## Instruction for Use Photometer 5010



**ROBERT RIELE GmbH & Co KG**

Software Version 9.0  
Documentation Version 01.2026

## SYMBOLS

The packaging material, the type plate on the instrument and the manual may contain the following symbols or abbreviations:



Manufacturer



Manufacturing date



This product fulfills the requirements of Regulation (EU) 2017/746 on in vitro diagnostic medical devices.



In vitro diagnostic medical device



Caution (refer to accompanying documents)!  
Please refer to safety-related notes in the manual accompanying this device.



Please consult instructions for use



Symbol for the marking of important information for appropriate handling of the device



Biohazard  
Samples containing material of human origin must be treated as potentially infectious. The relevant laboratory guidelines on safe use must be observed.



Symbol for the marking of electrical and electronic devices according to Appendix 3 (to § 9 Section 2) ElektroG3. The device should not be disposed of with normal household waste but must be collected separately. Old devices can be returned to us for proper disposal.

IP XO

No special protection against penetrating moisture (IP = International Protection)

REF

Order number

SN

Serial number

## INSTRUMENT APPROVALS

The Photometer 5010 meets the requirements of Regulation (EU) 2017/746 on in vitro diagnostic medical devices (IVDR). Furthermore, the Photometer 5010 is manufactured according to the special safety requirements for IVD medical devices stated in EN 61010.

## SAFETY INFORMATION

### Operator qualification

Only appropriately trained operators are qualified to operate the device.

The risk of erroneous information due to measurement errors, which leads to an incorrect diagnosis and/or the failure of a reliable therapy, must be minimized as far as possible through regular quality controls.

### Environmental conditions

The Photometer 5010 is approved for indoor use only.  
For further environmental conditions see chapter 10.1.

### Patient ambience

The Photometer 5010 may not be used in patient ambience.



### Electrical Safety

This device was examined and left the factory in perfect technical condition. To preserve this and protect safe and faultless operation, the operator must follow the orders and remarks of this operating manual.

Connect the device to grounded power outlets only. All peripheral devices that are connected to the Photometer 5010 must comply with safety standard EN 62368-1. Before connecting read the documentation of the peripheral devices.

Opening covers or removing parts of the instrument, except where this can be achieved manually without the use of any tool, may expose voltage-carrying components. Connectors can be live, too. Never try to maintain or repair an open instrument, which is carrying voltage.

Only authorized specialist staff may carry out repairs on the device including replacement of the Lithium battery. Through improper repairs, the warranty extinguishes, and the operator can be heavily jeopardized.

If suspected the device can no longer be operated safely, turn it off and take steps to ensure that no one will subsequently attempt to use it.

### Electromagnetic waves

Devices that emit electromagnetic waves may affect measured data or cause the Photometer 5010 to malfunction. Do not operate the following devices in the same room where the Photometer 5010 is installed: mobile phone, transceiver, cordless phone, and other electrical devices that generate electromagnetic waves.



### Reagents

Regarding reagents, follow the safety as well as the operating instructions of the manufacturers. Particular attention should be paid to storage and stability information in the package inserts. Please note the expiry date indicated on the reagent kit.

Pay attention to the currently valid German "Gefahrstoffverordnung" (GefStoffV)!



### Biological safety

Liquid waste is potentially biologically hazardous. Always wear gloves if handling those materials. Do not touch parts of the device other than those specified. Consult the laboratory protocol for handling biohazardous materials. Pay attention to the currently valid German "Biostoffverordnung" (BioStoffV)!



### Spillings and cleaning

If a sample is spilled on the device, wipe up immediately and apply disinfectant.



### Waste

Handle liquid waste properly, according to legislation on water pollution, and on the treatment of drainage and waste matter.

## MANUFACTURER'S WARRANTY

ROBERT RIELE GmbH & Co KG warrants Photometer 5010 against defects in material and workmanship. For further information contact the local distributor.

Any serious incident that has occurred in relation to the device shall be reported to the manufacturer and the competent authority of the Member State in which the user and/or the patient is established.

## WASTE MANAGEMENT NOTE

At the end of the life or utilization time the device and the accessories can be given back to the manufacturer with costs for an environmental waste disposal. The previous professional decontamination has to be proved with a certificate.

Address of the manufacturer:



ROBERT RIELE GmbH & Co KG  
Kurfuerstenstrasse 75-79  
13467 BERLIN  
GERMANY

Phone: +49 (0)30 404 40 87

Fax: +49 (0)30 404 05 29

E-Mail: [info@riele.de](mailto:info@riele.de)  
[www.riele.de](http://www.riele.de)

## QUALITY MANAGEMENT SYSTEM

ROBERT RIELE GmbH & Co KG maintains a quality management system according to ISO 13485, certified by mdc medical device certification GmbH.

# CONTENTS

<b>1</b>	<b>INTRODUCTION TO PHOTOMETER 5010</b>	<b>7</b>
<b>2</b>	<b>INSTALLATION</b>	<b>8</b>
2.1	DELIVERY	8
2.2	PREPARATION FOR INSTALLATION	8
2.3	INSTALLATION	8
2.4	LOADING PRINTER PAPER	9
2.5	SHUTTING-DOWN	9
<b>3</b>	<b>OPERATING ELEMENTS</b>	<b>10</b>
3.1	FRONT	10
3.2	BACK	10
3.3	TOUCHSCREEN	11
3.4	WORKING AREA	11
3.5	CUVETTE SYSTEM CHANGE	12
3.5.1	Changing cuvette system	12
3.5.2	Working with flow-through system	12
3.5.3	Working with standard cuvettes	13
3.6	POWER BANK	14
<b>4</b>	<b>PROGRAM SELECTION</b>	<b>15</b>
4.1	Measurement with programmed methods	15
4.2	Measurement with basic methods	16
4.3	Method editor	16
4.4	Utility programs	17
4.5	Line feed [LF]	17
<b>5</b>	<b>CALCULATION PROCEDURES</b>	<b>18</b>
5.1	GENERAL NOTES	18
5.1.1	Fundamental to the handling	18
5.1.2	Fundamental to the tempering	18
5.1.3	Fundamental to the inputs	18
5.1.4	Fundamental to the methods with standard	19
5.1.5	Fundamental to the methods with multi-standards	19
5.1.6	Fundamental to bichromatic measurements	19
5.1.7	Fundamental to the Kinetic	20
5.1.8	Fundamental to the methods with reagent blank	23
5.1.9	Fundamental to ID-NO. and sample numerator	23
5.1.10	Fundamental to storing test results	23
5.2	ABBREVIATIONS	24
5.3	SURVEY OF THE METHODS	25
5.4	DESCRIPTION OF METHOD PROCEDURES	26
5.4.1	Calculation procedure 1 (C/F)	27
5.4.2	Calculation procedure 2 (C/F/Rb)	28
5.4.3	Calculation procedure 3 (C/F/Sb)	29
5.4.4	Calculation procedure 4 (C/F/SbRb)	30
5.4.5	Calculation procedure 5 (C/S)	31
5.4.6	Calculation procedure 6 (C/S/Rb)	32
5.4.7	Calculation procedure 7 (C/S/Sb)	33
5.4.8	Calculation procedure 8 (C/S/SbRb)	34
5.4.9	Calculation procedure 9 (FTK/F/Rb)	35
5.4.10	Calculation procedure 10 (FTK/S/Rb)	36
5.4.11	Calculation procedure 11 (KIN/F/Rb)	37
5.4.12	Calculation procedure 12 (KIN/S/Rb)	38
5.4.13	Calculation procedure 13 (TRANSMISSION)	39
5.4.14	Calculation procedure 14 (C/F Delta)	40
5.4.15	Calculation Procedure 15 (C/F 3 WL)	42
5.4.16	Calculation Procedure 16 (DELTA R1R2)	43
<b>6</b>	<b>METHOD EDITOR</b>	<b>45</b>

<b>7</b>	<b>UTILITY PROGRAMS .....</b>	<b>48</b>
7.1	SELECTION OF UTILITY PROGRAMS.....	48
7.2	DESCRIPTION OF UTILITY PROGRAMS.....	49
7.2.1	Optic adjustment.....	49
7.2.2	Multi-standard functions.....	50
7.2.3	Printer ON / OFF.....	51
7.2.4	Pump menu .....	52
7.2.5	Menu serial com .....	55
7.2.6	Quality control.....	56
7.2.7	Settings printout.....	60
7.2.8	Stored results.....	61
7.2.9	Temperature ON / OFF.....	61
7.2.10	Temperature adjustment.....	61
7.2.11	Laboratory name.....	62
7.2.12	User name .....	62
7.2.13	Error list .....	63
7.2.14	Key signal ON / OFF.....	63
7.2.15	Touchscreen adjustment.....	63
7.2.16	Date / Time .....	64
7.2.17	Language.....	65
7.2.18	ADC counts (Optic).....	65
7.2.19	Bar Code.....	65
7.2.20	Service tools .....	67
<b>8</b>	<b>MAINTENANCE .....</b>	<b>68</b>
8.1	CLEANING INSTRUCTION .....	68
8.2	CALIBRATING MEASURING SYSTEM.....	68
8.3	ADJUSTMENT OF BUBBLE DETECTOR .....	68
8.4	CALIBRATION OF PERISTALTIC PUMP.....	68
8.5	REPLACEMENT OF PAPER ROLL.....	68
8.6	REPLACEMENT OF ASPIRATION TUBE.....	69
8.7	REPLACEMENT OF LINE FUSES.....	69
<b>9</b>	<b>ERROR MESSAGE / CORRECTION.....</b>	<b>70</b>
9.1	GENERAL NOTE .....	70
9.2	ACOUSTIC ERROR MESSAGES.....	70
9.3	PLAINTEXT ERROR MESSAGES.....	70
9.4	CODED ERROR MESSAGES .....	71
<b>10</b>	<b>TECHNICAL DATA.....</b>	<b>74</b>
10.1	ENVIRONMENTAL CONDITIONS.....	74
10.2	MINIMAL OPERATION QUALITY.....	74
10.3	TYPE PLATE .....	74
10.4	SHORT SPECIFICATIONS.....	75
10.5	TECHNICAL SPECIFICATIONS.....	76
<b>11</b>	<b>ACCESSORIES AND SPARE PARTS.....</b>	<b>78</b>
<b>12</b>	<b>METHOD LIST .....</b>	<b>79</b>
12.1	BASIC METHODS.....	79
12.2	LIST OF USER SPECIFIC METHODS .....	81

# 1 INTRODUCTION TO PHOTOMETER 5010

## Intended Purpose:

This device is a semi-automated clinical chemistry analyzer used to quantitatively determine clinical chemistry analytes in human serum, plasma and other clinical specimens from patients of all ages and independent of gender. The chemistry analyzer is used in combination with in vitro diagnostic reagents designed for manual procedures to be used by qualified laboratory technicians. Quality control is performed with clinical chemistry standards, calibrators and controls available from the respective manufacturers of reagents.

It is operated via touchscreen. Remote control is possible by a serial data interface (chapter 7.2.5 - Menu serial com – REMOTE CONTROL).

For measuring methods several programmed methods with open parameters are available (chapter 5 - CALCULATION PROCEDURES and chapter 12 - METHOD LIST).

Besides, up to 231 methods - built up on the basic methods - can be established and stored by the operator with a method editor. A list of methods can be printed out (chapter 6 - METHOD EDITOR).

Up to 50 nonlinear calibration curves with maximum 20 sets of points can be stored (chapter 7.2.2 - Multi-standard functions).

Photometer 5010 offers a flexible cuvette concept: A special flow-through cuvette and a peristaltic pump provide for speedy operation with an optimal tempering of the measuring solution. Alternatively, the flow-through cuvette can be removed, and the measuring solution can be measured in one-way or glass cells in the standard cuvette compartment.

By means of a combination of transistor and Peltier element the solution reaches fast and accurately the selected temperature, programmable in 1°C steps between 25°C - 41°C.

The Photometer 5010 is standard equipped with six optical filters of wavelengths 340, 405, 492, 546, 578 and 623 nm. If required, they can be exchanged against any wavelength within the range of 340-730 nm. Three additional filters, e.g. 670 nm, can be installed.

The device is equipped with a thermal printer.

The measuring data can be stored and managed in the Photometer 5010 (chapter 7.2.8 - Stored results).

According to a GLP conformal documentation the names of lab and operator can be printed out as well as transferred to EDP (chapter 7.2.5 - Menu serial com – EDP ON/OFF).

In Photometer 5010 up to 50 methods can be supervised with a quality control (chapter 7.2.6 - Quality control).

Numerous utility programs permit the individual configuration of the device. Function tests support the analysis of sources of error.

Photometer 5010 is future-proof by FLASH MEMORY technology: The operating system can be updated with program novelties and/or improvements comfortably, without having to open the equipment (please ask distributor for further information).

## 2 INSTALLATION

### 2.1 DELIVERY

Check the device and contents of the enclosed box as follows on visible transport damages and completeness:

- 1 Operating Instructions/Scan me QR Code
- 1 Aspiration tube
- 1 External power supply
- 2 Thermal printer paper
- 1 Pump tube with joints
- 1 Top cover small for printer
- 1 Waste tube
- 1 Dust cover
- 1 Optional: power bank



Inform the sales office immediately about transport damages. Keep the original packaging for a possible return.

### 2.2 PREPARATION FOR INSTALLATION

Place the device on a stable, level surface. Do not obstruct the input air at the bottom and the waste air at the back plate to guarantee the ventilation of the device.

If the device was exposed to extraordinary fluctuation in temperature and/or humidity, it must acclimatize sufficiently before operation.



Before connecting the waste tube to the pump tube remove pump tube at both ends from the metal clamps. The waste tube of the flow-through system must be led through the tunnel to the backside of the device (chapter 3.2 - BACK) and then into any drain tank.

### 2.3 INSTALLATION

The Photometer 5010 is powered by an external power supply. (Input voltage (device): 12 VDC, Power supply input range: 100 VAC to 240 VAC, 50/60 Hz (universal input)). In addition, the device can be powered by an alternative voltage source such as the supplied power bank or battery, solar panel, vehicle electrical system, etc.

Connect the low-voltage plug of the power supply to the power input socket on the back of the device. Then insert the mains plug of the power supply into a grounded mains outlet.



While connecting or disconnecting an external device (PC, printer) to Photometer 5010 both devices must be switched off.

Switch on Photometer 5010 by the mains switch at the back.



Greeting screen:

After switching on copyright, website, type of device and version designation are displayed and - in the case of activated printer - printed out.

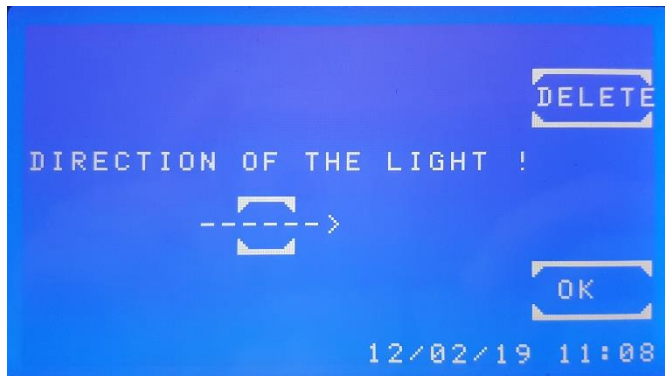

Indication for the direction of the light in version 7 with LED.

[DELETE] Window will not be displayed next time.

(Appears again when overwriting the software or when initializing the system.)

[OK] Exit the window. Window appears again next time you turn the device on.

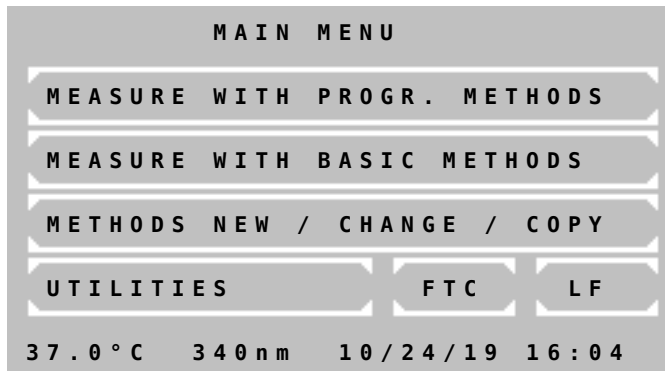

After around 15 minutes the device is heated up and ready for measurement.

First the tempering is switched off. If working with tempered material is required later, switch on the tempering already now either directly by the utility program (chapter 7.2.9 - Temperature ON / OFF) or indirectly by selection of a method with programmed tempering (chapter 5.1 - GENERAL NOTES).

If errors appeared during operation, first of all they have to be confirmed with [E] before remedy (chapter 9 - ERROR MESSAGE / CORRECTION).

## 2.4 LOADING PRINTER PAPER

With initial operation or if the colored end of the paper roll appears, printer paper must be inserted:

- Open the printer cover.
- Put the green head-up lever in the up position.
- Remove the rest of paper.
- Put the green head-up lever in the down position.
- Put printer paper axis into the new printer paper reel.
- Insert the paper inside the printer. The roller will automatically feed the paper for about 4 cm.
- Press [LF] several times for line-feed until the paper has a length of about 5 cm. In case of no reaction the printer may be deactivated.
- Insert printer paper reel into the axis guide.
- Push the printer paper through the slot in the printer cover and close the printer with the cover.

## 2.5 SHUTTING-DOWN

- Before shutting-down the photometer it is absolutely necessary to wash the tube system repeatedly with distilled water or another appropriate rinse solution by pressing [WASH] or sipping lever [P]. After cleaning the system should be emptied. No residues should be inside.
- The pump tube must not be tensed during longer time out. Tension release:  
The upper connection of the pump tube can be loosened easily from the metal clamps.

### 3 OPERATING ELEMENTS

#### 3.1 FRONT

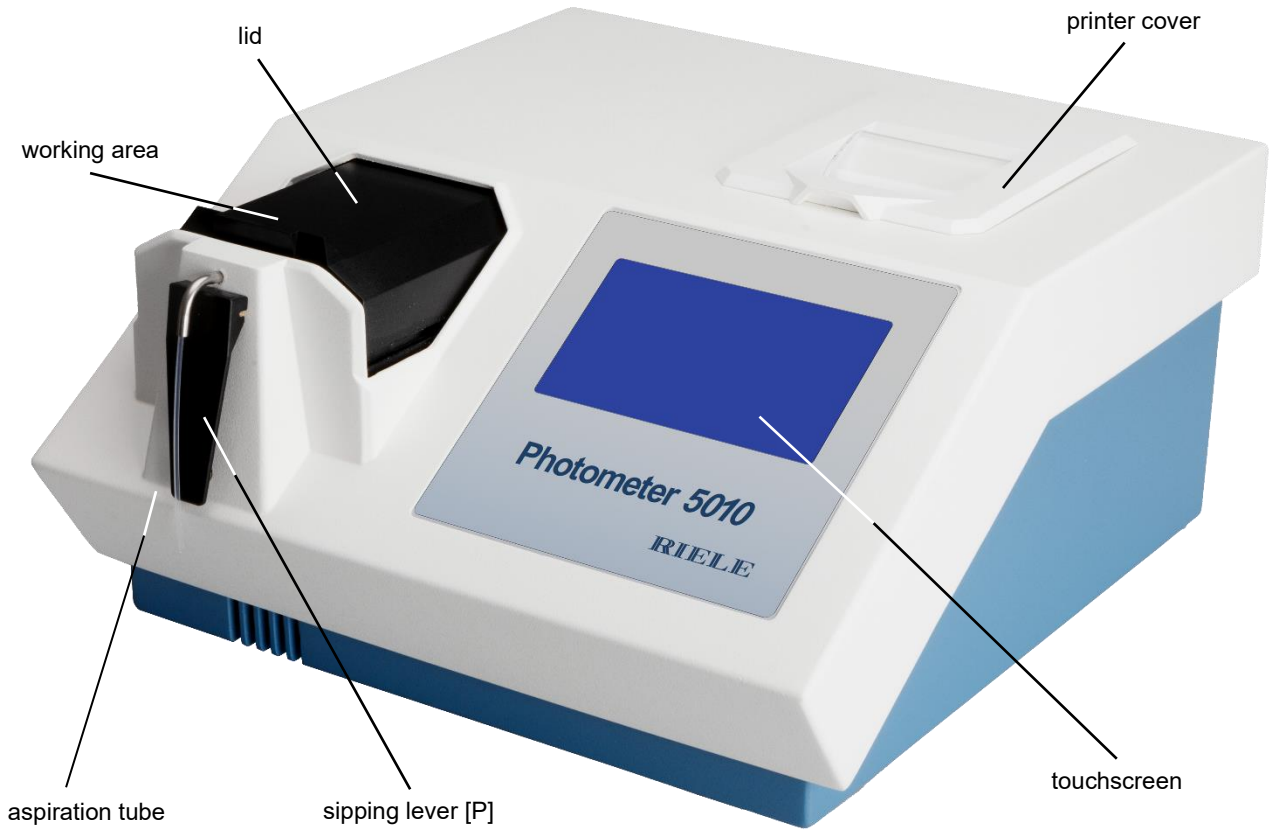

#### 3.2 BACK



### 3.3 TOUCHSCREEN

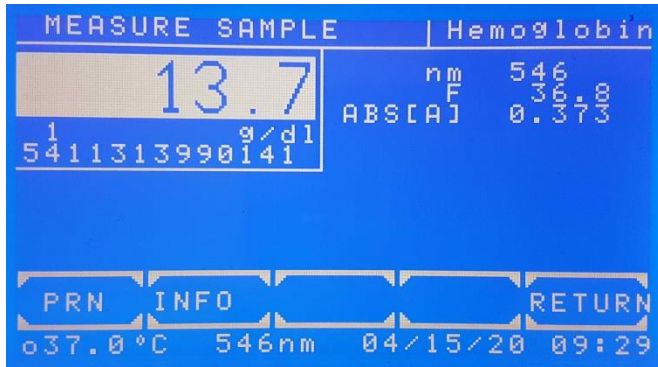

The touchscreen shows applications and information. It is contact-sensitive and reacts to the pressure exerted on it. In order to execute a function, the desired range on the screen must be touched



The surface of the touchscreen may be never touched with ball-point pen, pencil or another pointed article!

### 3.4 WORKING AREA

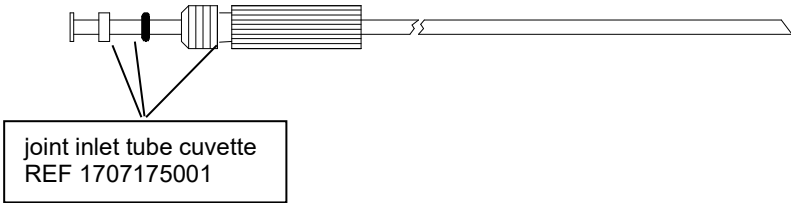
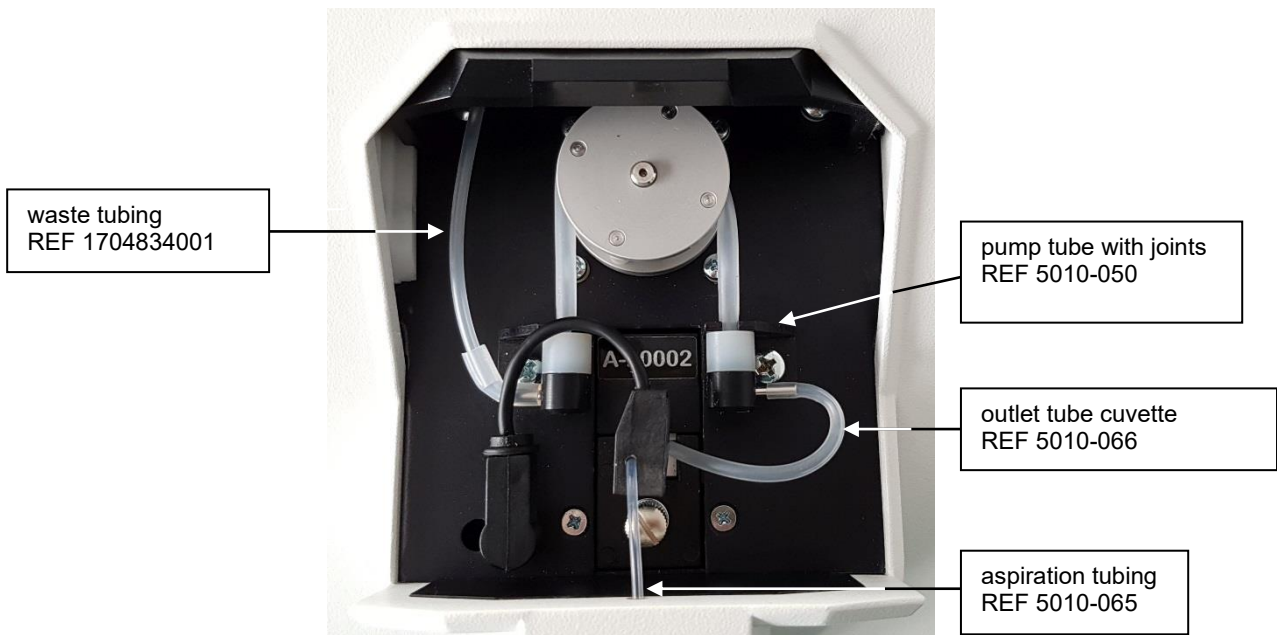

### 3.5 CUVETTE SYSTEM CHANGE

#### 3.5.1 Changing cuvette system

If the insertable flow-through cuvette is installed, first the tubing system must be emptied: Go to the main menu and execute a washing process by sipping lever [P] five times. Air is aspirated and the residual liquid is pumped off through the waste tube.

If a flow system is installed, disconnect the bubble detector, remove the aspiration tube from the metal tube and disconnect the outlet tube cuvette from the joints of the pump tube.

Take out the removable flow-through cuvette.

After removing the flow-through cuvette, in the main menu the respective system must be selected: Either standard cuvette [S-CUV] or flow-through cuvette [FTC]. An optic adjustment should be done after reaching operating temperature (see chapter 7.2.1 - Optic adjustment).

Direction of the light path:

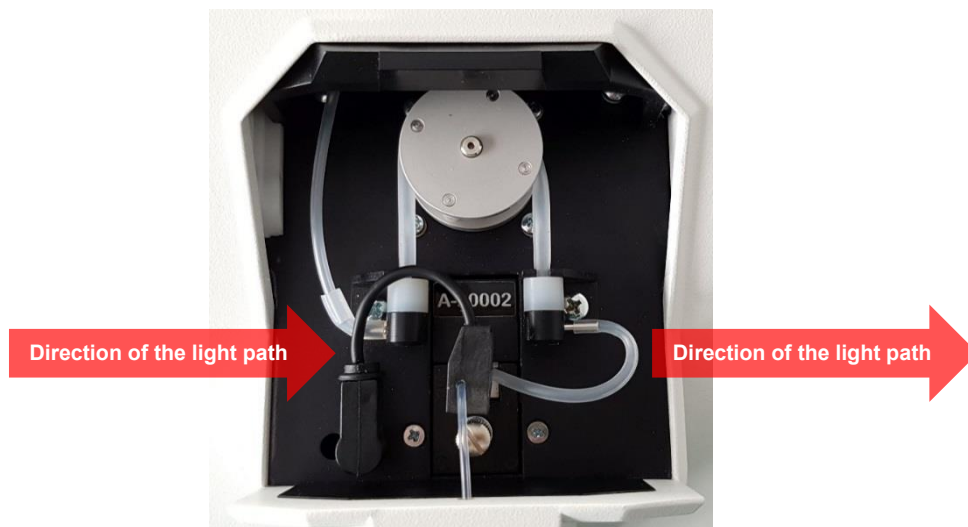

#### 3.5.2 Working with flow-through system

Install the discrete flow-through cuvette. Select flow-through cuvette [FTC] in the main menu. Lead the aspiration tube with attached bubble detector without sharp bend from the working area through the metal tube. Fasten outlet tube cuvette to the metal nipple of the cuvette as well as to the joint of the pump tube.



Before connecting the tubes remove pump tube at both ends from the metal clamps. The pump tube must not be tensed during longer time out (fig. below).



The lid of the cuvette compartment may stay open. The optic is not sensitive to stray light.



Discrete flow trough cuvette (REF 5010-216) with aspiration tubing and bubble detector. Aspiration tube should show to the front of the device and the metal tube to the back.



**Tension release:**  
The upper connection of the pump tube can be loosened easily from the metal clamps.

Plug the bubble detector to the socket in the working area. It must sit as close as possible at the connection of the flow-through cuvette. For working without bubble detector switch off this function (chapter 7.2.4.3 - **Bubble detector ON / OFF**).



While working with the flow-through system the tubes must not be sharply bended. No residues should be inside. Check from time to time that the tubing and the connections are leakproof. After each replacement of tubing execute a **Pump calibration** (chapter 7.2.4.2).



Before as well as after all measuring it is absolutely necessary to wash the tube system repeatedly with distilled water or another appropriate rinse solution by pressing [WASH] or sipping lever [P]. This is also necessary after a method change (chapter 8.1 - CLEANING INSTRUCTION). For the procedure within a measuring series see the application regulation.

In order to aspirate solution into the measuring system put the aspiration tube deeply enough into the respective vessel.

Before setting to zero press [ZERO]. Trigger setting to zero by sipping lever [P].

Trigger a normal measuring by sipping lever [P]. Repeat a measuring of a solution which is already aspirated by [RESULT].

To work in optimized volume mode use the function **Volume optimized ON / OFF** (chapter 7.2.4.3.2). This function makes it possible, for example, to pump two consecutive times 500 µl from 1000 µl sample volume.

### 3.5.3 Working with standard cuvettes

Remove the flow-through cuvette. Select the standard cuvette [S-CUV.] in the main menu.



The optical path is directed from left to right of the device. Insert single cuvette according to the drawing **OPTIC CONSTRUCTION** in TECHNICAL DATA.



The lid of the cuvette compartment may stay open. However, we recommend closing it to avoid stray light.

Trigger setting to zero by [ZERO].

Trigger a normal measuring by [RESULT].

### 3.6 POWER BANK

#### Function Description

Power bank DC round socket can be connected to the power input socket of photometer

- DC Output voltage: + 12 V<sub>DC</sub> (preset by RIELE)
- DC Output Current: 5 A<sub>DC</sub>
- AC Input voltage: 100 V<sub>AC</sub> – 240 V<sub>AC</sub>
- Input Frequency: 50/60 Hz
- DC Connector: 

#### Location

External



Power bank

Briefly press the power switch (on/off) to activate the output. Your photometer can now be turned on. The LED display provides information about the active DC output and the remaining capacity for the power bank. Once you turn the photometer off, the output of the power bank will automatically turn off.

After pressing the power button (on/off) the charge level will be indicated. This is a digital display in %.

#### Recharging the power bank

It is possible to connect the power bank simultaneously or after usage to a charger USB QC3 using the USB-C input to charge the power bank.

The power bank supports runtimes of the photometer

Quick Charge	Without	With
Photometer 5010	> 3h	> 8h

#### Checking the 12V output of the power bank:

Disconnect the power bank from the photometer. Use the ON/Off switch to check the required voltage of 12V by pressing and hold the button for at least 3s until the display flashes. The voltage is indicated.



Do not press again since it will change the voltage! The correct output voltage must be selected to prevent damaging the photometer.

We assume no guarantee if you use a power bank that is not recommended by us. The voltage of 12V is preset by RIELE and must not be changed. In doubt, please check before use.

## 4 PROGRAM SELECTION

After switch-on the touchscreen shows the main menu.

From this screen the basic methods (unalterably programmed in the system) or operator specific programmed methods can be reached. In addition, the adjusting programs are started from this mask. With the method editor own methods can be established and changed. The utility programs cover the configuration adjustments and check routines. Selection of the respective cuvette system: standard cuvette [S-CUV.] or flow-through cuvette [FTC]. The line feed function of printer can directly be reached by [LF].

After completion of a method or execution of a utility program the program always returns to the main menu.

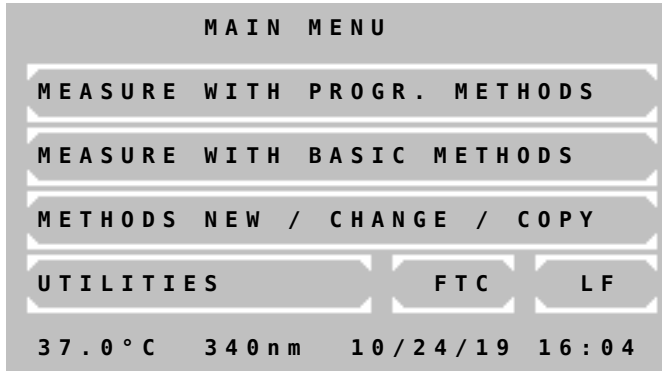

### Main menu:

Down in the status line from left to right following is shown:

- Current temperature of the cuvette compartment in °C.  
In the case of switched off tempering the display changes between --.-C und xx.xx°C.  
In the case of switched on tempering and instable temperature the display changes between --.-C and e.g. 37.3°C. In the case of stable temperature the current temperature of e.g. 37.0°C is shown. Small fluctuations of the value are normal.
- Date in the format day/month/year
- Time

### 4.1 Measurement with programmed methods

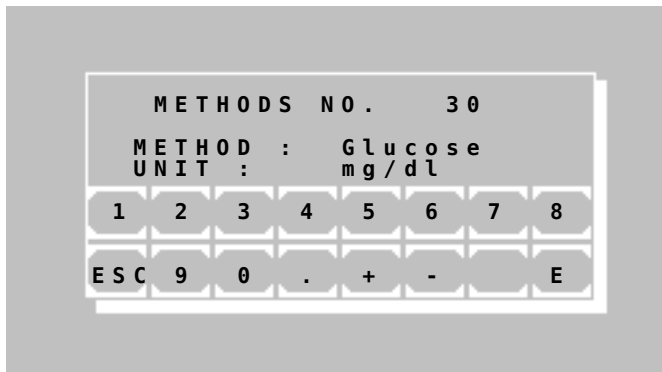

A programmed method for a photometric test can be called directly by input of the method number.

The valid range for a method number lies between 20 and 250.

Scroll all existing methods by [+] or [-]. If no method is programmed, a plain text error message (chapter 9.3 - PLAINTEXT ERROR MESSAGES) is shown.

Call the selected method by [E].  
Return to main menu by [ESC].

**i** A programmed method can be established via menu METHOD NEW /CHANGE / COPY (chapter 4.3 - Method editor). The transmission of a method collection is possible by PC with special software.

Further information:  
Application sheets of reagent manufacturers

## 4.2 Measurement with basic methods

A photometric test can be executed by a method already permanently programmed, but open in all setting parameters. 16 different methods with different calculation procedures are available. Each of these methods can serve as prototype for a method programmed by the operator.

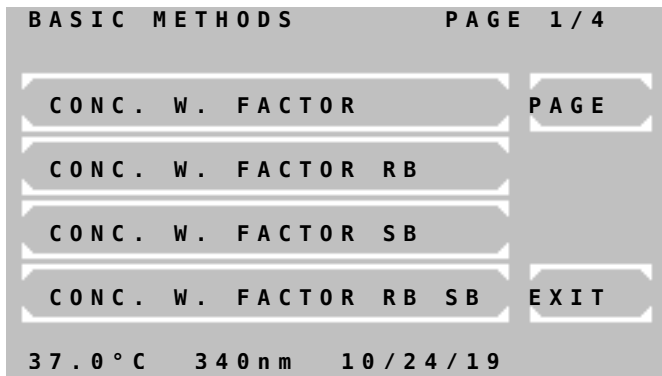

Available are:

- Absorbance measurement
- Concentration measurement / end point measurement
- Fixed time kinetic / two point kinetic
- Kinetic
- Transmission

Scrolling through all methods is possible by [PAGE]. The current page is shown at the right upper screen corner. By [END] the program returns to the main menu.

A method is selected by pressing the corresponding key.

The following abbreviations are used for the distinction of the methods:

- CONC. = concentration
- KIN = kinetic
- FTK = fixed time kinetic
- F = factor
- STD = standard
- RB = reagent blank
- SB = sample blank

Further information:

Chapter: 5 - CALCULATION PROCEDURES

## 4.3 Method editor

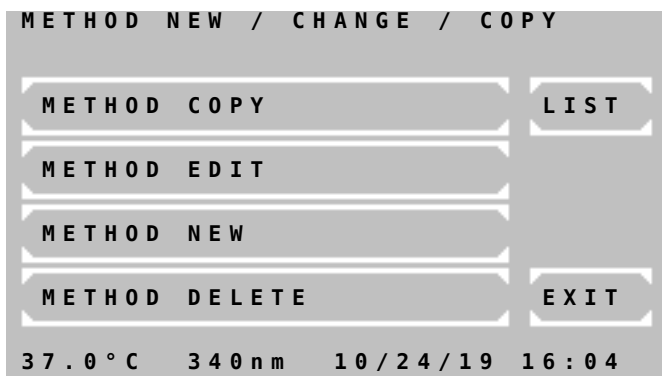

Each photometric test can be permanently stored with its setting parameters by the method editor.

With the functions of the method editor are possible the new installation, the change and removing a method.

By [LIST] an overview of the programmed methods can be printed and transmitted via the serial interface.

Further information:

Chapter: 6 - METHOD EDITOR

#### 4.4 Utility programs

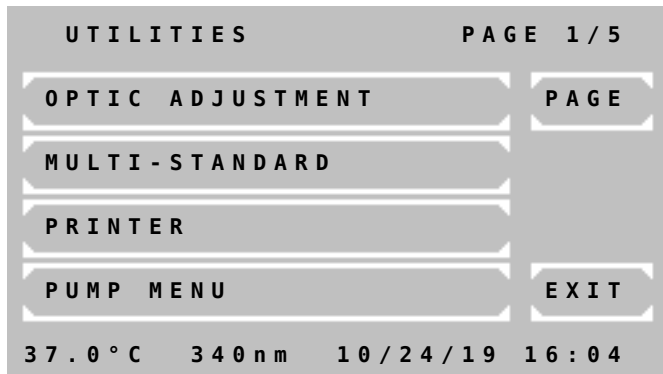

Utility programs are necessary for the adjustment and maintenance of Photometers 5010.

Further information:  
Chapter: 7 - UTILITY PROGRAMS

#### 4.5 Line feed [LF]

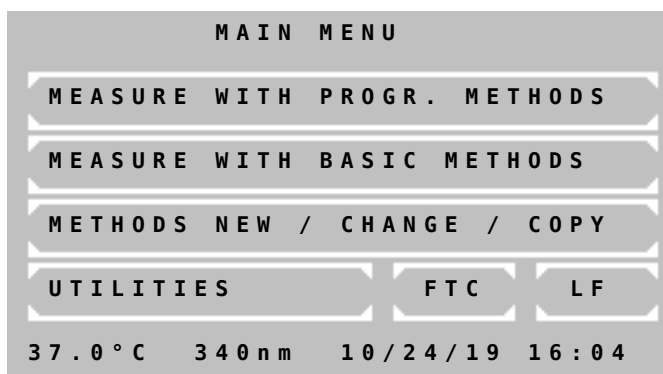

Pressing [LF] in the main menu triggers a line feed in the case of activated printer. Several lines can be advanced by continuous pressure on [LF].

## 5 CALCULATION PROCEDURES

### 5.1 GENERAL NOTES

The device offers operator guidance in the display by a combination of plaintext and short terms.

Messages and inputs regarding the method always have to be confirmed by [OK]. By [EXIT] all methods can be broken off. For a restart see chapter 4 - PROGRAM SELECTION. Measuring is generally triggered by sipping lever [P] or [RESULT], zero measuring by [ZERO] and sipping lever [P] (chapter 3.5.2 - Working with flow-through system and 3.5.3 - Working with standard cuvettes -).

#### 5.1.1 Fundamental to the handling ...

- When measuring with standard cuvettes the lid of the cuvette compartment may stay open during measurement.
-  Deviations from normal operation, caused by the device or by the operator, are notified by "ERROR". They always have to be confirmed by [E] (chapter 9 - ERROR MESSAGE / CORRECTION).

Example 1: The reading exceeds the programmed upper limit

Example 2: Too little liquid when sucking in a measuring solution

#### 5.1.2 Fundamental to the tempering ...

- Tempering switched on or off is parameter of a method.
- After switching on the tempering, it lasts up to 10 minutes until a constant temperature is reached.
- The current temperature of the flow-through cuvette or standard cuvette system is shown at the lower edge of the touchscreen. For meaning of the display see chapter 4 - PROGRAM SELECTION /MAIN MENU. A temperature instable or out of tolerance during measuring is marked by an asterisk (\*) at the utmost right position in the corresponding print line.  
To avoid deviations due to temperature influence a delay between triggering and actual measuring can be programmed in each method.
- For a quick mode of operation all temperature-sensitive samples, reagents and washing solutions should be externally tempered by Incubator T12/T16 (REF 500-002 / 500-001) or a water bath.

#### 5.1.3 Fundamental to the inputs ...

- The input format of the factor and/or the standard with sign determines the output format of the result concerning the number of decimal places.  
Example: With factor "36.8" the calculated concentration will be shown with one decimal place.
- Each factor or standard can be minus signed, so that the result is calculated with correct sign.  
Example: The test GOT is programmed with the factor "-1746" because the measuring principle implies a decreasing absorbance.
- If for the factor or standard a "zero" is pre-programmed, during operation the user is asked to type in the actual value. Here, the input format of the "zero", e.g. "0" or "=0.0" determines the output. The old standard/factor of a previous measurement can be reused for further ones.
- For a homogeneous solution the input of a delay before a measuring is possible at all methods.
- All delay times can be cancelled by pressing the aspiration tube [P] for a long time.

#### 5.1.4 Fundamental to the methods with standard ...

- Each measuring of a standard (calibrator) can be executed as single, double or triple determination. Following is shown:

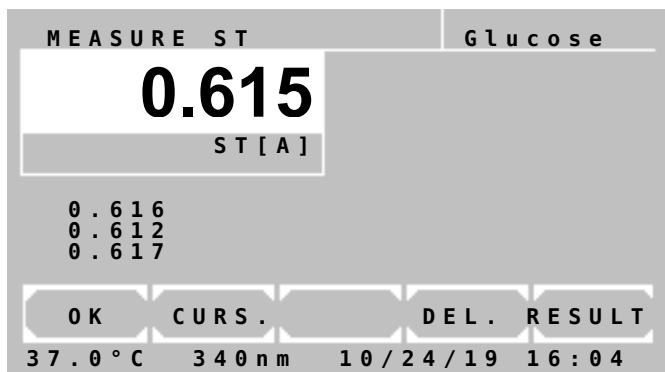

In the white reading window the averaged absorbance of the standard is shown.

Below the white reading window the absorbance 1, 2 and 3 of a standard are shown.

By [OK] the average of all values is taken over. Values with 0 are ignored and excluded from the calculation. The resulting factor is calculated from the average of the standard.

By [CURS.] a value is selected. A flashing white square marks the current value.

By [DEL.] a value is deleted and excluded from the calculation.

By [RESULT] a measuring is triggered.

- The determined resulting factor of a standard measurement is stored together with the corresponding method number. After renewed selection of this method the last resulting factor is offered as "OLD STD".
- The principle of the multiple measurement can also be expanded to all measurements. The corresponding entry can be set invoking a basic method. The parameter is definable in preprogrammed methods (chapter 6 - METHOD EDITOR).

#### 5.1.5 Fundamental to the methods with multi-standards ...

- Linear calibration is used in the case of two calibrators. The absorbance forms a linear diagram with the concentrations (chapter 7.2.2 - Multi-standard functions).
- Nonlinear calibration is used for samples with a nonlinear but reproducible connection between the absorbance and the concentrations. At least three (maximum 20) calibrators are required for nonlinear calibration (chapter 7.2.2 - Multi-standard functions).

#### 5.1.6 Fundamental to bichromatic measurements ...

- The calculation procedures based on endpoint measurement (CP 1 to CP 8, CP 13 and CP 14) can be executed bichromatic. The zero measurement will be done with a wavelength defined as bichromatic. The bichromatic wavelength might be not included in the standard set of filters. The bichromatic wavelength can be set after calling a method (chapter 6 METHOD EDITOR Fig. 6.5).

### 5.1.7 Fundamental to the Kinetic...

In a kinetic method the sample absorbance is measured several times in pre-established time intervals.

The user can define a delay time and a quantity and duration of time intervals after the delay time (Deltas or  $\Delta t$ ).

At the beginning and at the end of the delay time the absorbance values ABS.1 and ABS.2 are measured respectively. The difference  $|ABS.1 - ABS.2|$  allows the differentiation between normal and abnormal activities.

This is followed by a sequence of measurements in regular time intervals (Deltas or  $\Delta t$ ). An example of a resulting curve is shown in Fig. 5.1.7.1:

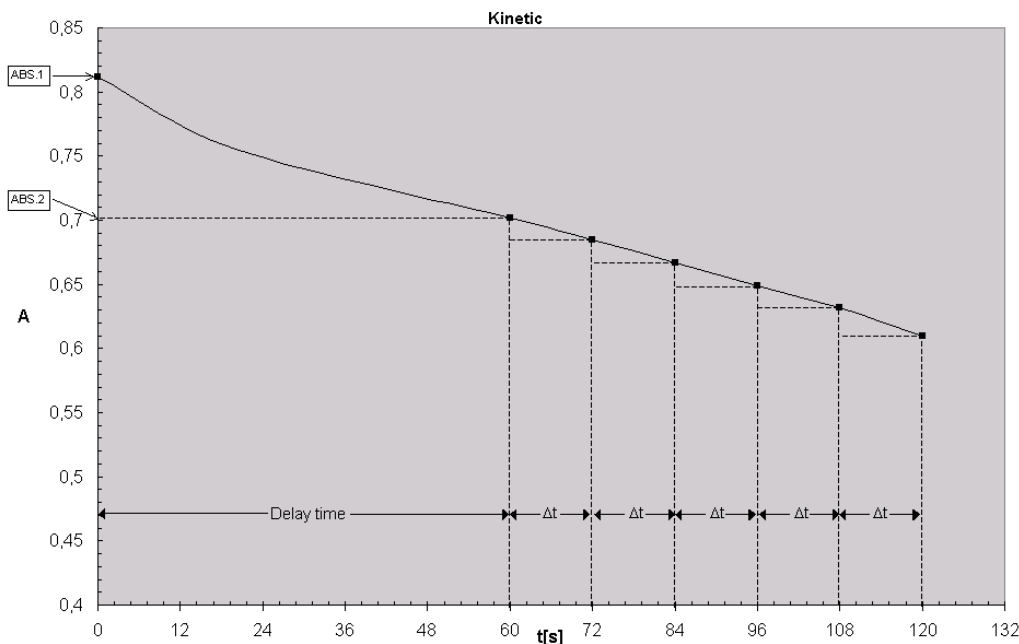

Fig. 5.1.7.1: Resulting curve of kinetic test, decreasing absorbance

In each time interval (Delta or  $\Delta t$ ) the difference between the relating absorbance values as well as the gradient of the curve are calculated.

To obtain the alteration per minute  $\Delta A_{S,Minute}$  the gradients must be averaged. This is done by a simple linear regression calculation also giving an indicator for the linearity of the test. This indicator is called the coefficient of correlation R. For practical reasons, the square of the coefficient of correlation  $R^2$  or coefficient of determination is taken in a Kinetic calculation. The value of  $R^2$  can vary between 0 and 1. An  $R^2$  value of 1 indicates perfect linearity and a value of 0 indicates absolute non-linearity. Already values  $< 0.9$  indicate a bad linearity and therefore an incorrect test. In order to improve the linearity of the kinetic only the best three deltas are considered in the calculation procedure of the regression calculation. Therefore, at least five deltas are required when programming a new method. If this procedure does not lead to an improvement all deltas are reconsidered in the calculation procedure.

In practice, linear tests show values of  $R^2$  near to 1. In the example for Calculation procedure 11 (KIN/F/Rb) values of  $R^2 \geq 0.998$  are permitted. Results with smaller  $R^2$  values could be caused by temperature instability, pollution, expired reagents, unfavorable delay time, etc.

For a better monitoring the number of deltas (deltas or  $\Delta t$ ) should be bigger than specified for the manual procedure. The classic three-minutes-test with three deltas of 60 s can be replaced by 15 deltas of 12s.

When programming a new method, which is based on CP 11 or CP 12, it is possible to set lower and upper limits for the measurement result within the method editor (see chapter 6 - METHOD EDITOR, Fig. 6.5). This can be achieved setting the parameters MIN. VALUE and MAX. VALUE. If the measured value exceeds the MAX. VALUE, a message RANGE MAX. is shown, and if the measured value falls below, MIN. VALUE message RANGE MIN. is shown. Also a lower limit for  $R^2$  can be entered by setting MIN.  $R^2$ , if the obtained  $R^2$  value falls below the entered value a message NON-LINEAR is shown.

In order to get positive results at tests with decreasing absorbance (see Fig. 5.1.7.1), a negative factor has to be entered. Only if MAX. VALUE is set and the sign of the measured value is not equal to the sign of the entered MAX. VALUE a message RANGE +/- is shown.

The parameters MIN. VALUE, MAX. VALUE and MIN.  $R^2$  are deactivated entering a zero value.

Presentation of the results on the display after a successful measurement:

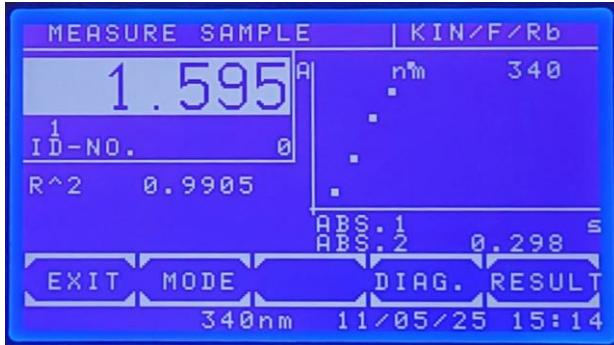

View after the successful measurement

The sequence of kinetics can be seen on the display during the measurement for an early assessment.

By [DIAG] the progress of the kinetic is shown in more detail.

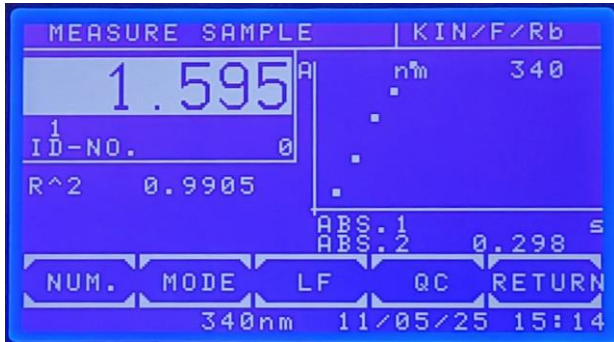

View after confirming by [MODE].

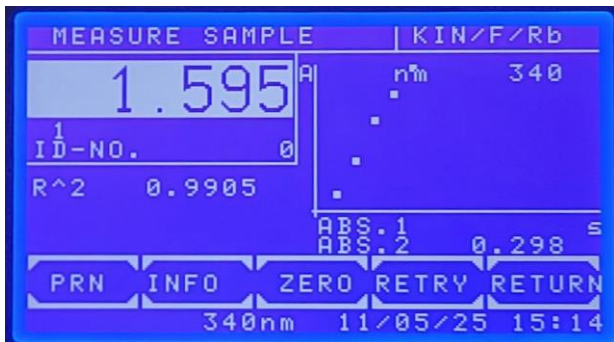

View after pressing [MODE] [MODE]

By [PRN] the internal printer is switched off.  
By [INFO] all immediate test results are shown or printed.

By [ZERO] the zero measurement is repeated.

The measurement is repeated by [RETRY].

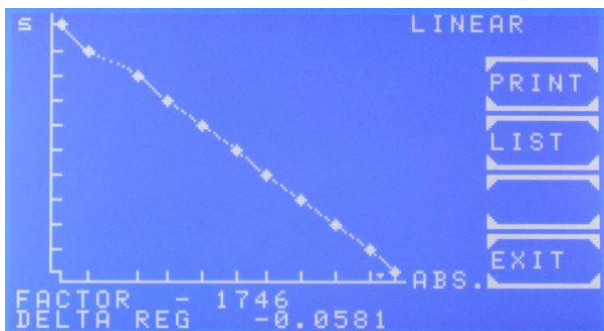

View after pressing [DIAG.]

The progress of the kinetic is shown after a few seconds.

The axis of time is marked by [s], the axis of extinction is marked by [ABS]

The currently used FACTOR and the calculated DELTA REG are shown in the bottom lines.

If R^2 is activated, the term LINEAR or NON-LINEAR is shown in the upper right corner. By [PRINT] a graphical printout is generated. By [LIST] all data points are shown sequentially.

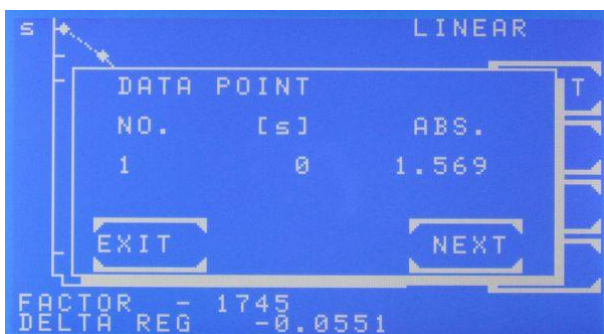

Sequential View of data points after confirming [DIAG] and [LIST]

By [NEXT] for each data point the numeration, the time [s] and the extinction is shown.

Presentation of the results on the printout after a successful measurement:

PHOTOMETER 5010 #30001  
 V9.Xa dd/mm/yy D  
 LAB.: RIELE BERLIN  
 USER 1: M.MUSTERMANN  
 DATE: 09/03/25  
 TIME: 08:44:12  
 METHOD 11: KIN/F/Rb  
 PROGRAM: 11  
 FACTOR: 4130.0  
 WAVELENGTH: 340nm  
 TEMPERATURE: 37C  
 DELAY: 180s  
 DELTAS: 6  
 TIME/DELTA: 30s  
 UNIT: U/l

-----  
 MEASURE ZERO

OLD Rb[A]: 0.000

NO.	ABS.	RESULT
1	0.107	150.8
	R^2:	0.9994

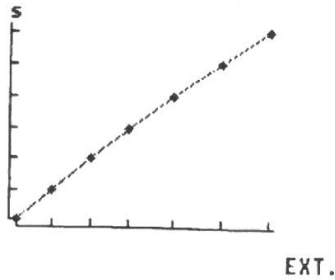

NO.	TIME [s]	ABS.
1	0	0.718
2	30	0.734
3	60	0.750
4	90	0.767
5	120	0.785
6	150	0.805
7	180	0.825

ABS.1:	0.642
ABS.2:	0.750
1:	0.0312
2:	0.0320
3: x	0.0345
4: x	0.0364
5: x	0.0387
6:	0.0417
DELTA REG:	0.0365

ABS = ABS.2 - ABS.1  
 RESULT = DELTA REG x FACTOR

Printout after confirming [DIAGR.] and [PRINT]

The chronic of the kinetic is printed. The axis of time is marked by [s]; the axis of extinction is marked by [ABS].

In the next step a chart including all data points is printed.

Printout after confirming [MODE], [MODE] and [INFO].

$\Delta$ ABS/min

As of five programmed deltas in case of an improvement of the linearity the three best deltas are considered and marked with a "x". If this procedure does not lead to an improvement all deltas are reconsidered in the calculation procedure and none of the deltas are marked.

### 5.1.8 Fundamental to the methods with reagent blank...

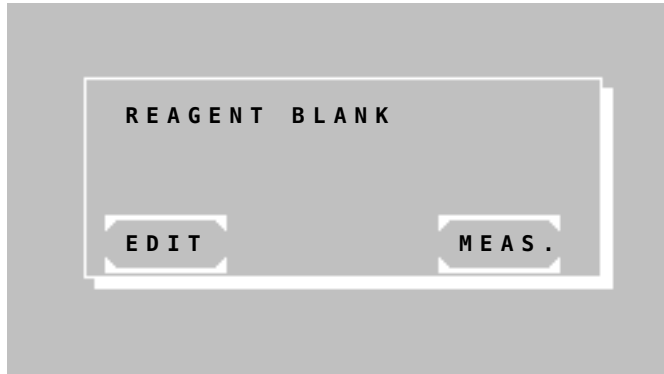

After selecting a method with reagent blank (RB), the reagent blank can be measured, entered or put on zero.

Press [EDIT] to enter the RB manually or [MEAS.] to measure it.

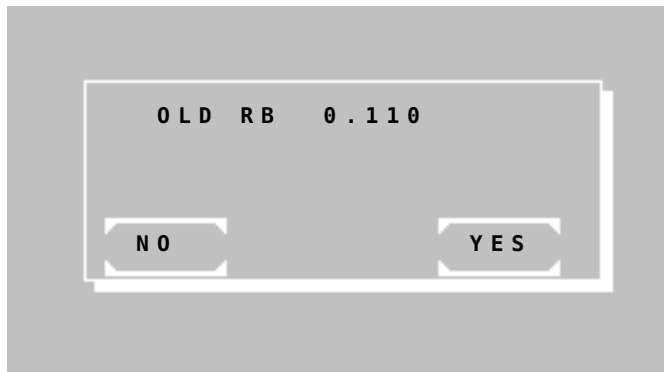

When using a programmed method based on a calculation procedure with RB, the used RB will be stored together with the corresponding method number.

After renewed selection of this method the last stored reagent blank is offered as "OLD RB".

Press [YES] to use the last stored RB or [NO] to enter or measure it.

### 5.1.9 Fundamental to ID-NO. and sample numerator...

- All test results are labeled with a numerator.
- Additionally, all results can be labeled with a 5-digit ID-NO. When the ID-NO. is not zero, it will be displayed and printed together with the sample result.
- When a method is selected you can edit both numerator and ID-NO. of a sample with [MODE] [NUM.]

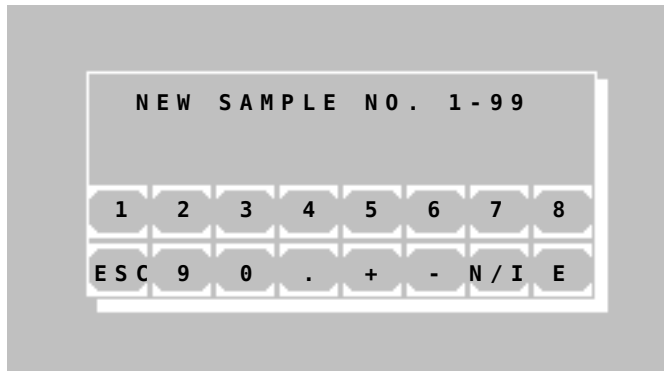

Press [N / I] to switch between editing numerator and ID-NO.

### 5.1.10 Fundamental to storing test results...

- All test results are stored automatically. Up to 1000 results can be stored in memory.
- See Table 7.2.5.1 for the format of the stored data.
- Stored results can be output through serial interface (chapter 7.2.8 - Stored results).
- When memory is full oldest test results will be overwritten, or you can send all results through the serial interface and then delete them.

## 5.2 ABBREVIATIONS

A, ABS	.....	Absorbance
A <sub>RB</sub>	.....	Absorbance of reagent blank
A <sub>RB,0</sub>	.....	At Fixed Time: absorbance of reagent blank after incubation time T <sub>0</sub>
A <sub>RB,1</sub>	.....	At Fixed Time: absorbance of reagent blank after reaction time T <sub>1</sub>
A <sub>S</sub>	.....	Absorbance of sample
A <sub>S,0</sub>	.....	At Fixed Time: absorbance of sample after incubation time T <sub>0</sub>
A <sub>S,1</sub>	.....	At Fixed Time: absorbance of sample after reaction time T <sub>1</sub>
A <sub>SB</sub>	.....	Absorbance of sample blank
A <sub>ST</sub>	.....	Absorbance of standard
A <sub>ST,0</sub>	.....	At Fixed Time: absorbance of standard after incubation time T <sub>0</sub>
A <sub>ST,1</sub>	.....	At Fixed Time: absorbance of standard after reaction time T <sub>1</sub>
A <sub>STB</sub>	.....	Absorbance of standard blank
C	.....	Concentration
C <sub>ST</sub>	.....	Concentration of standard
CV	.....	Quality control: Coefficient of variation
dA/min	.....	At Kinetic: $\Delta A / \text{min}$
$\Delta A_{RB, \text{Minit}}$	.....	At Kinetic: change of reagent blank per minute (measured in $\Delta A / \text{min}$ )
$\Delta A_{S, \text{Minit}}$	.....	At Kinetic: change of sample per minute (measured in $\Delta A / \text{min}$ )
F	.....	Factor
FTK	.....	Fixed Time Kinetic
KIN	.....	Kinetic
n	.....	Quality control: number of values
nm	.....	Nanometer (dimension of wavelength)
m	.....	Quality control: mean of values
R	.....	Result, Sample
Rb	.....	Reagent blank
R <sup>2</sup>	.....	At Kinetic: square of correlation coefficient or coefficient of determination shows the linearity of a test
S, ST	.....	Standard
STb	.....	Standard blank
Sb	.....	Sample blank
s	.....	Quality control: standard deviation
TRANSM., T	.....	Transmission in %
T <sub>0</sub>	.....	At Fixed Time: incubation time in seconds
T <sub>1</sub>	.....	At Fixed Time: reaction time in seconds
T <sub>1</sub>	.....	At Kinetic: time per delta in seconds

### 5.3 SURVEY OF THE METHODS

The calculation procedures, on which all methods are traceable from the list of methods, are mentioned in the following table. Criterion is the characteristic of the calculation procedure (see below). For detailed description of the respectively accompanying procedure of method see chapter 5.4 - DESCRIPTION OF METHOD PROCEDURES.

CP-No.	Characteristic	Method	Calculation formula
CP 1	C/F	Endpoint with Factor	$C = F * A_S$
CP 2	C/F/Rb	Endpoint with Factor	$C = F * (A_S - A_{RB})$
CP 3	C/F/Sb	Endpoint with Factor	$C = F *  A_S - A_{SB} $
CP 4	C/F/SbRb	Endpoint with Factor	$C = F * ( A_S - A_{SB}  - A_{RB})$
CP 5	C/S	Endpoint with Standard	$C = F * A_S$
CP 6	C/S/Rb	Endpoint with Standard	$C = F * (A_S - A_{RB})$
CP 7	C/S/Sb	Endpoint with Standard	$C = F *  A_S - A_{SB} $
CP 8	C/S/SbRb	Endpoint with Standard	$C = F * ( A_S - A_{SB}  - A_{RB})$
CP 9	FTK/F/Rb	Fixed Time Kinetic with Factor	$C = F * ( A_{S,0} - A_{S,1}  -  A_{RB,0} - A_{RB,1} )$
CP 10	FTK/S/Rb	Fixed Time Kinetic with Standard	$C = F * ( A_{S,0} - A_{S,1}  -  A_{RB,0} - A_{RB,1} )$
CP 11	KIN/F/Rb	Kinetic with Factor	$C = F * (\Delta A_{S,Minit} - \Delta A_{RB,Minit})$
CP 12	KIN/S/Rb	Kinetic with Standard	$C = F * (\Delta A_{S,Minit} - \Delta A_{RB,Minit})$
CP 13	TRANSM.	Transmission in %	
CP 14	C/F DELTA	Endpoint with Factor	$C = F * (\Delta A_{S2-Sb2} - \Delta A_{S1-Sb1})$
CP 15	C/F 3 WL	Measurement with 3 Wavelengths	$C = 168 * A_{415nm} - 84 * A_{380nm} - 84 * A_{450nm}$
CP 16	DELTA R1R2	Diff. measurement of two reagents	$C = \Delta A_S$

#### Explanations:

CP-No. ....Number of the calculation procedure (chapter 6 - METHOD EDITOR)

Characteristic .....Name of the calculation procedure (chapter 12.1 - BASIC METHOD)

Calculation formula .....Calculation basis of basic method

## 5.4 DESCRIPTION OF METHOD PROCEDURES

In the descriptions of the calculation procedures a typical print-out by the internal printer is shown on the left side. All examples were built with active pump. In case of measurements without pump the volumes for sipping the media are not printed.

All print-outs begin with the device information, laboratory data and method parameters followed by all measuring data necessary for a manual examination of the readings.

### The measuring window

The arrangement of the measuring window is alike in all calculation procedures. Depending on the method, various numbers of readings or diagrams are shown.

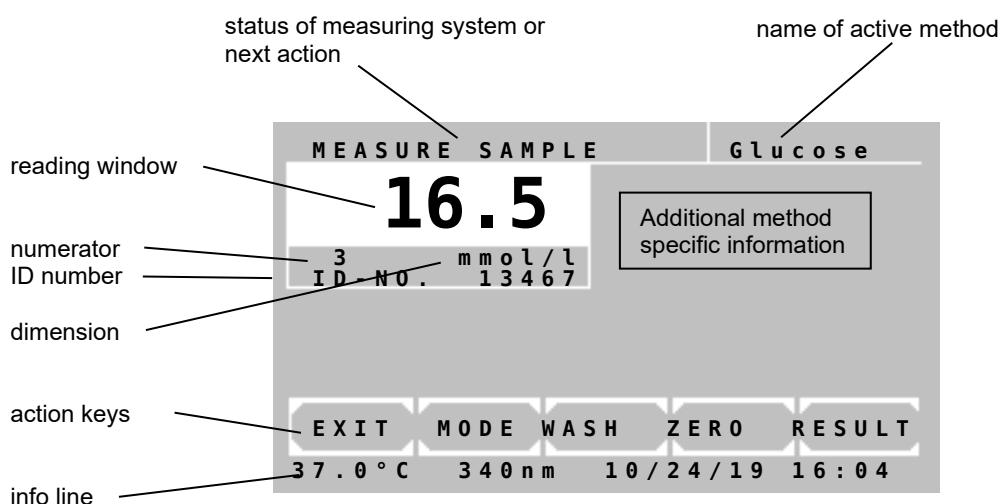

### Functions of the action keys in the measuring window:

[EXIT]	Leads to the query whether the measuring program is to be terminated																				
[MODE]	Occupies the action keys with following mode functions: <table> <tr> <td>[NUM.]</td> <td>[MODE]</td> <td>[LF]</td> <td>[QC]</td> <td>[RETURN]</td> </tr> <tr> <td>[PRN]</td> <td>[INFO]</td> <td></td> <td>[M-STD]</td> <td>[RETURN]</td> </tr> <tr> <td>[PRN]</td> <td>[INFO]</td> <td>[ZERO]</td> <td>[RETRY]</td> <td>[RETURN]</td> </tr> <tr> <td>[PRN]</td> <td>[INFO]</td> <td>[ZERO]</td> <td>[E1/E2]</td> <td>[RETURN]</td> </tr> </table>	[NUM.]	[MODE]	[LF]	[QC]	[RETURN]	[PRN]	[INFO]		[M-STD]	[RETURN]	[PRN]	[INFO]	[ZERO]	[RETRY]	[RETURN]	[PRN]	[INFO]	[ZERO]	[E1/E2]	[RETURN]
[NUM.]	[MODE]	[LF]	[QC]	[RETURN]																	
[PRN]	[INFO]		[M-STD]	[RETURN]																	
[PRN]	[INFO]	[ZERO]	[RETRY]	[RETURN]																	
[PRN]	[INFO]	[ZERO]	[E1/E2]	[RETURN]																	
[WASH]	With activated pump the wash volume defined to the method is pumped																				
[ZERO]	Starts the zero measuring With activated pump the sipping lever [P] must also be pressed																				
[RESULT]	Starts the measuring With activated pump a solution already sipped is measured once again To aspirate and measure a new sample press sipping lever [P]																				

### Mode functions:

[NUM.]	Edit sample numerator or ID-NO. (chapter 5.1.9)
[LF]	Line Feed
[QC]	Quality Control functions
[PRN]	Switch printer ON/OFF / printout of current time by [TIME]
[INFO]	Display/printout of detailed results
[M-STD]	Multi standard functions
[E1/E2]	Change to measuring E2 (chapter 5.4.14)
[RETRY]	Repeat a measurement
[RETURN]	Return to normal functions

**5.4.1 Calculation procedure 1 (C/F)**

Method at which a measured sample value  $A_S$  is multiplied with a predefined factor F.

Calculation procedure .....CP 1  
 Characteristic ..... C / F  
 Method .....End Point with Factor  
 Calculation formula .....  $C = F * A_S$   
 Factor ..... given / entering

<p>PHOTOMETER 5010 #30001                  V9.Xa dd/mm/yy D                  LAB.: RIELE BERLIN                  USER 1: M.MUSTERMANN                  DATE: 09/03/25                  TIME: 08:44:12                  METHOD 20: HEMOGLOBIN                  PROGRAM: 1                  FACTOR: 29.4                  WAVELENGTH: 405nm                  TEMPERATURE: 37C                  MEAS. VOLUME: 900u<math>\mu</math>l                  WASH VOLUME: 1000u<math>\mu</math>l                  DELAY: 5s                  MAX.UNITS: 25                  UNIT: g/l                  -----                  MEASURE ZERO                    NO. ABS. RESULT                  1 0.675 19.8                  2 0.843 24.8</p>	<p>Start method selection in the main menu.                  See chapter:                  4.1 - Measurement with programmed methods                  4.2 - Measurement with basic methods</p> <p>In the case of activated printer the print-out of the method data follows.</p> <p>The measuring window is shown.</p> <p>Method procedure:</p> <p>→Insert / measure zero solution</p> <p>→Insert / measure sample</p> <p>→Insert / measure sample</p>
--	--

**5.4.2 Calculation procedure 2 (C/F/Rb)**

Method at which the difference of sample value  $A_S$  and reagent blank  $A_{RB}$  is multiplied with a given factor  $F$ . The reagent blank  $A_{RB}$  is entered or measured once.

Calculation procedure .....CP 2  
 Characteristic ..... C / F / Rb  
 Method .....End Point with Factor  
 Calculation formula .....  $C = F * (A_S - A_{RB})$   
 Factor ..... given / entering  
 Reagent blank .....entering or measuring

<pre> PHOTOMETER 5010 #30001 V9.Xa dd/mm/yy D LAB.: RIELE BERLIN USER 1: M.MUSTERMANN DATE: 09/03/25 TIME: 08:44:12 METHOD 21: HDL -C PROGRAM: 2 FACTOR: 325 WAVELENGTH: 546nm TEMPERATURE: 37C MEAS. VOLUME: 900uL WASH VOLUME: 1000uL DELAY: 5s UNIT: mg/dL ----- MEASURE ZERO  Rb[A]: 0.058  NO. ABS. RESULT 1 1.064 327 2 1.188 367 3 1.340 417                 </pre>	<p>Start method selection in the main menu.                  See chapter:                  4.1 - Measurement with programmed methods                  4.2 - Measurement with basic methods</p> <p>In the case of activated printer the print-out of the method data follows.</p> <p>The measuring window is shown.</p> <p>Method procedure:</p> <p>→Insert / measure zero solution</p> <p>→Insert / measure reagent blank</p> <p>→Insert / measure sample</p> <p>→Insert / measure sample</p> <p>→Insert / measure sample</p>
--	---

### 5.4.3 Calculation procedure 3 (C/F/Sb)

Method at which the difference of sample value  $A_S$  and sample blank  $A_{SB}$  regarding the amount is multiplied with a given factor  $F$ . The sample blank  $A_{SB}$  is measured before every test.

Calculation procedure .....CP 3  
 Characteristic ..... C / F / Sb  
 Method .....End Point with Factor  
 Calculation formula .....  $C = F * |A_S - A_{SB}|$   
 Factor ..... given / entering

<p>PHOTOMETER 5010 #30001                  V9.Xa dd/mm/yy D                  LAB.: RIELE BERLIN                  USER 1: M.MUSTERMANN                  DATE: 09/03/25                  TIME: 08:44:12                  METHOD 23: BILIRUBIN                  PROGRAM: 3                  FACTOR: 12.80                  WAVELENGTH: 546nm                  TEMPERATURE: 37C                  MEAS. VOLUME: 900uL                  WASH VOLUME: 1000uL                  DELAY: 5s                  MAX.UNITS: 8.0                  UNIT: mg/dL</p> <p>-----                  MEASURE ZERO</p> <table border="1"> <thead> <tr> <th>NO.</th> <th>ABS.</th> <th>RESULT</th> </tr> </thead> <tbody> <tr> <td>1</td> <td>1.000</td> <td>4.21</td> </tr> <tr> <td></td> <td>Sb[A]:</td> <td>0.671</td> </tr> <tr> <td>2</td> <td>1.215</td> <td>4.25</td> </tr> <tr> <td></td> <td>Sb[A]:</td> <td>0.884</td> </tr> <tr> <td>3</td> <td>1.033</td> <td>4.23</td> </tr> <tr> <td></td> <td>Sb[A]:</td> <td>0.702</td> </tr> </tbody> </table>	NO.	ABS.	RESULT	1	1.000	4.21		Sb[A]:	0.671	2	1.215	4.25		Sb[A]:	0.884	3	1.033	4.23		Sb[A]:	0.702	<p>Start method selection in the main menu.                  See chapter:                  4.1 - Measurement with programmed methods                  4.2 - Measurement with basic methods</p> <p>In the case of activated printer the print-out of the method data follows.</p> <p>The measuring window is shown.</p> <p>Method procedure:                  →Insert / measure zero solution</p> <p>→Insert / measure sample blank                  →Insert / measure sample</p> <p>→Insert / measure sample blank                  →Insert / measure sample</p> <p>→Insert / measure sample blank                  →Insert / measure sample</p>
NO.	ABS.	RESULT																				
1	1.000	4.21																				
	Sb[A]:	0.671																				
2	1.215	4.25																				
	Sb[A]:	0.884																				
3	1.033	4.23																				
	Sb[A]:	0.702																				

#### 5.4.4 Calculation procedure 4 (C/F/SbRb)

Method at which the reagent blank  $A_{RB}$  is subtracted of the difference of sample value  $A_S$  and sample blank  $A_{SB}$  regarding the amount, and this difference is multiplied with a given factor  $F$ .  
The sample blank  $A_{SB}$  is measured before every test. The reagent blank  $A_{RB}$  is entered or measured once.

Calculation procedure .....CP 4  
Characteristic ..... C / F / SbRb  
Method .....End Point with Factor  
Calculation formula .....  $C = F * ( |A_S - A_{SB}| - A_{RB} )$   
Factor ..... given / entering  
Reagent blank .....entering or measuring

PHOTOMETER 5010 #30001 V9.Xa dd/mm/yy D LAB.: RIELE BERLIN USER 1: M.MUSTERMANN DATE: 09/03/25 TIME: 08:44:12 METHOD 24: Fe PROGRAM: 4 FACTOR: 1330 WAVELENGTH: 578nm TEMPERATURE: 37C MEAS. VOLUME: 900u $\mu$ l WASH VOLUME: 1000u $\mu$ l DELAY: 5s MIN.UNITS: 37 MAX.UNITS: 158 UNIT: ug/dl ----- MEASURE ZERO Rb[A]: 0.085 NO. ABS. RESULT 1 0.715 154 Sb[A]: 0.486 2 0.646 49 Sb[A]: 0.497	Start method selection in the main menu. See chapter: 4.1 - Measurement with programmed methods 4.2 - Measurement with basic methods In the case of activated printer the print-out of the method data follows. The measuring window is shown. Method procedure: →Insert / measure zero solution →Insert / measure reagent blank →Insert / measure sample blank →Insert / measure sample →Insert / measure sample blank →Insert / measure sample
--	--

#### 5.4.5 Calculation procedure 5 (C/S)

Method at which a measured absorbance value  $A_S$  is multiplied with a factor  $F$  which is determined by measuring of a standard solution with known concentration  $C_{ST}$ .

Calculation procedure .....CP 5  
 Characteristic .....C / S  
 Method ..... End Point with Standard  
 Calculation formula .....  $C = F * A_S$   
 Resulting factor .....  $F = C_{ST} / A_{ST}$

<pre> PHOTOMETER 5010 #30001 V9.Xa dd/mm/yy D LAB.: RIELE BERLIN USER 1: M.MUSTERMANN DATE: 09/03/25 TIME: 08:44:12 METHOD 25: GLUCOSE PROGRAM: 5 STANDARD: 5.55 WAVELENGTH: 546nm TEMPERATURE: 37C MEAS. VOLUME: 900uL WASH VOLUME: 1000uL DELAY: 3s MAX.UNITS: 22.2 UNIT: mmol/L - - - - - MEASURE ZERO  ST[A] 1: 1.110 ST[A] 2: 1.093 ST[A] 3: 1.059  ST[A]: 1.088 FACTOR: 5.10  NO. ABS. RESULT 1 1.026 5.23 2 1.357 6.92 3 1.582 8.07           </pre>	<p>Start method selection in the main menu.          See chapter:          4.1 - Measurement with programmed methods          4.2 - Measurement with basic methods</p> <p>In the case of activated printer the print-out of the method data follows.</p> <p>The measuring window is shown.</p> <p>Method procedure:</p> <p>→Insert / measure zero solution</p> <p>→Insert / measure standard 1          →Insert / measure standard 2 (optional)          →Insert / measure standard 3 (optional)</p> <p>(Averaged standard)          (Resulting factor)</p> <p>→Insert / measure sample</p> <p>→Insert / measure sample</p> <p>→Insert / measure sample</p>
---	---

#### 5.4.6 Calculation procedure 6 (C/S/Rb)

Method at which the difference of sample value  $A_S$  and reagent blank  $A_{RB}$  is multiplied with a factor  $F$  which is determined by measuring of a standard solution with known concentration  $C_{ST}$  and under consideration of reagent blank  $A_{RB}$ .

The reagent blank  $A_{RB}$  is entered or measured once.

Calculation procedure .....CP 6  
 Characteristic ..... C / S / Rb  
 Method ..... End Point with Standard  
 Calculation formula .....  $C = F * (A_S - A_{RB})$   
 Resulting factor .....  $F = C_{ST} / (A_{ST} - A_{RB})$   
 Reagent blank ..... entering or measuring

<p>PHOTOMETER 5010 #30001            V9.Xa dd/mm/yy D            LAB.: RIELE BERLIN            USER 1: M.MUSTERMANN            DATE: 09/03/25            TIME: 08:44:12            METHOD 26: SODIUM            PROGRAM: 6            STANDARD: 150.0            WAVELENGTH: 405nm            TEMPERATURE: 37C            MEAS. VOLUME: 900uL            WASH VOLUME: 1000uL            DELAY: 3s            MAX. UNITS: 300            UNIT: mmol/L</p> <hr/> <p>MEASURE ZERO</p> <p>Rb[A]: 0.108</p> <p>ST[A] 1: 1.112            ST[A] 2: 1.132            ST[A] 3: 1.118</p> <p>ST[A]: 1.121            FACTOR: 148.2</p> <table border="1"> <thead> <tr> <th>NO.</th> <th>ABS.</th> <th>RESULT</th> </tr> </thead> <tbody> <tr> <td>1</td> <td>1.449</td> <td>198.7</td> </tr> <tr> <td>2</td> <td>1.118</td> <td>149.6</td> </tr> <tr> <td>3</td> <td>2.006</td> <td>281.2</td> </tr> </tbody> </table>	NO.	ABS.	RESULT	1	1.449	198.7	2	1.118	149.6	3	2.006	281.2	<p>Start method selection in the main menu.            See chapter:            4.1 - Measurement with programmed methods            4.2 - Measurement with basic methods</p> <p>In the case of activated printer the print-out of the method data follows.</p> <p>The measuring window is shown.</p> <p>Method procedure:</p> <p>→Insert / measure zero solution</p> <p>→Insert / measure reagent blank</p> <p>→Insert / measure standard 1            →Insert / measure standard 2 (optional)            →Insert / measure standard 3 (optional)</p> <p>(Averaged standard)            (Resulting factor)</p> <p>→Insert / measure sample</p> <p>→Insert / measure sample</p> <p>→Insert / measure sample</p>
NO.	ABS.	RESULT											
1	1.449	198.7											
2	1.118	149.6											
3	2.006	281.2											

**5.4.7 Calculation procedure 7 (C/S/Sb)**

Method at which the difference of sample value  $A_S$  and sample blank  $A_{SB}$  regarding the amount is multiplied with a factor  $F$  which is determined by measuring of a standard solution with known concentration  $C_{ST}$  and under consideration of standard blank  $A_{STB}$ .

The sample blank  $A_{SB}$  is measured before every test.

Calculation procedure .....CP 7  
 Characteristic ..... C / S / Sb  
 Method ..... End Point with Standard  
 Calculation formula .....  $C = F * |A_S - A_{SB}|$   
 Resulting factor .....  $F = C_{ST} / |A_{ST} - A_{STB}|$

<pre> PHOTOMETER 5010 #30001 V9.Xa dd/mm/yy D LAB.: RIELE BERLIN USER 1: M.MUSTERMANN DATE: 09/03/25 TIME: 08:44:12 METHOD 27: UREA COL PROGRAM: 7 STANDARD: 50.0 WAVELENGTH: 546nm TEMPERATURE: 37C MEAS. VOLUME: 900u1 WASH VOLUME: 1000u1 DELAY: 3s MAX. UNITS: 220 UNIT : mg/dl - - - - - MEASURE ZERO  ST[A] 1: 0.614 ST[A] 2: 0.629 ST[A] 3: 0.620  ST[A]: 0.621 STb[A]: 0.106 DELTA ST: 0.515 FACTOR: 97.1  NO. ABS. RESULT 1 2.292 197.6 Sb[A]: 0.257 2 2.340 198.0 Sb[A]: 0.300 3 2.223 197.2 Sb[A]: 0.193                 </pre>	<p>Start method selection in the main menu.                  See chapter:                  4.1 - Measurement with programmed methods                  4.2 - Measurement with basic methods</p> <p>In the case of activated printer the print-out of the method data follows.</p> <p>The measuring window is shown.</p> <p>Method procedure:</p> <p>→Insert / measure zero solution                  →Insert / measure standard blank</p> <p>→Insert / measure standard 1                  →Insert / measure standard 2 (optional)                  →Insert / measure standard 3 (optional)                  (Averaged standard)                  (standard blank)                  (Averaged standard minus standard blank)                  (Resulting factor)</p> <p>→Insert / measure sample blank                  →Insert / measure sample</p> <p>→Insert / measure sample blank                  →Insert / measure sample</p> <p>→Insert / measure sample blank                  →Insert / measure sample</p>
--	---

### 5.4.8 Calculation procedure 8 (C/S/SbRb)

Method at which the reagent blank  $A_{RB}$  is subtracted of the difference of sample value  $A_S$  and sample blank  $A_{SB}$  regarding the amount and this difference is multiplied with a factor  $F$  which is determined by measuring of a standard solution with known concentration  $C_{ST}$  and under consideration of standard blank  $A_{STB}$  and the reagent blank  $A_{RB}$ .

The sample blank  $A_{SB}$  is measured before every test. The reagent blank  $A_{RB}$  is entered or measured once.

Calculation procedure .....CP 8  
 Characteristic .....C / S / SbRb  
 Method ..... End Point with Standard  
 Calculation formula .....  $C = F * ( |A_S - A_{SB}| - A_{RB} )$   
 Resulting factor .....  $F = C_{ST} / ( |A_{ST} - A_{STB}| - A_{RB} )$   
 Reagent blank ..... entering or measuring

PHOTOMETER 5010 #30001 V9.Xa dd/mm/yy D LAB.: RIELE BERLIN USER 1: M.MUSTERMANN DATE: 09/03/25 TIME: 08:44:12 METHOD 28: Ca PROGRAM: 8 STANDARD: 8.02 WAVELENGTH: 546nm TEMPERATURE: 37C MEAS. VOLUME: 900uL WASH VOLUME: 1000uL DELAY: 3s MAX.UNITS: 12 UNIT: mg/dL - - - - - MEASURE ZERO Rb[A]: 0.150 ST[A] 1: 1.485 ST[A] 2: 1.521 ST[A] 3: 1.495 ST[A]: 1.501 STb[A]: 0.479 DELTA ST: 1.022 FACTOR: 8.74 NO. ABS. RESULT 1 1.495 7.89 Sb[A]: 0.489 2 1.542 7.89 Sb[A]: 0.535 3 1.394 8.39 Sb[A]: 0.329	Start method selection in the main menu. See chapter: 4.1 - Measurement with programmed methods 4.2 - Measurement with basic methods In the case of activated printer the print-out of the method data follows. The measuring window is shown. Method procedure: →Insert / measure zero solution →Insert / measure reagent blank →Insert / measure standard blank →Insert / measure standard 1 →Insert / measure standard 2 (optional) →Insert / measure standard 3 (optional) (Averaged standard) (standard blank) (Averaged standard minus standard blank) (Resulting factor) →Insert / measure sample blank →Insert / measure sample →Insert / measure sample blank →Insert / measure sample →Insert / measure sample blank →Insert / measure sample
---	---

### 5.4.9 Calculation procedure 9 (FTK/F/Rb)

Method at which a reagent blank is measured after an incubation time ( $\Rightarrow A_{RB,0}$ ) and after a reaction time ( $\Rightarrow A_{RB,1}$ ) and also a sample after an incubation time ( $\Rightarrow A_{S,0}$ ) and after a reaction time ( $\Rightarrow A_{S,1}$ ). The difference from the change of the test and the change of the reagent blank is multiplied by a predefined factor F. The reagent blank  $A_{RB}$  is entered or measured once.

During the procedure the dialog asks for the use of a reagent blank. The default value is OFF. To continue without reagent blank press [NO].

After each measurement the next sample can be measured with [NEXT].  
With [RESULT] it is possible to measure the same sample again.

Calculation procedure .....CP 9  
Characteristic ..... FTK / F / Rb  
Method ..... Fixed Time with Factor  
Calculation formula .....  $C = F * ( |A_{S,0} - A_{S,1}| - |A_{RB,0} - A_{RB,1}| )$   
Factor ..... given / entering  
Reagent blank ..... entering or measuring

<pre> PHOTOMETER 5010 #30001 V9.Xa dd/mm/yy D LAB.: RIELE BERLIN USER 1: M.MUSTERMANN DATE: 09/03/25 TIME: 08:44:12 METHOD 29: CK-MB PROGRAM: 9 FACTOR: 2751.3 WAVELENGTH: 340nm TEMPERATURE: 37C MEAS. VOLUME: 900uL WASH VOLUME: 1000uL INCUBATION: 120s REACTION: 180s MAX.UNITS: 1500 UNIT: U/l - - - - - MEASURE ZERO  Rb[A]: 0.145 DELTA [A]: 0.121  NO. ABS. RESULT 1 0.346 -0.14 DELTA [A]: 0.053 2 1.029 1128.1 DELTA [A]: 0.410 3 0.829 1381.2 DELTA [A]: 0.502 </pre>	<p>Start method selection in the main menu. See chapter: 4.1 - Measurement with programmed methods 4.2 - Measurement with basic methods</p> <p>In the case of activated printer the print-out of the method data follows.</p> <p>The measuring window is shown.</p> <p>Method procedure: →Insert / measure zero solution</p> <p>Without reagent blank (insert / measure optionally)</p> <p>→Insert / measure sample</p> <p>→Insert / measure sample</p> <p>→Insert / measure sample</p>
--	---

#### 5.4.10 Calculation procedure 10 (FTK/S/Rb)

Method at which a reagent blank is measured after an incubation time ( $\Rightarrow A_{RB,0}$ ) and after a reaction time ( $\Rightarrow A_{RB,1}$ ) and also a sample after an incubation time ( $\Rightarrow A_{S,0}$ ) and after a reaction time ( $\Rightarrow A_{S,1}$ ). The difference from the change of the sample and the change of the reagent blank becomes multiplied with a factor F which is determined by means of the change of standard solution  $|A_{ST,0}-A_{ST,1}|$  and the change of reagent blank  $|A_{RB,0}-A_{RB,1}|$  during the reaction time and given concentration of standard. The reagent blank  $A_{RB}$  is entered or measured once.

During the procedure the dialog asks for the use of a reagent blank. The default value is OFF. To continue without reagent blank press [ENTER].

After each measurement the next sample can be measured with [NEXT].  
With [RESULT] it is possible to measure the same sample again.

Calculation procedure .....CP 10  
Characteristic ..... FTK / S / Rb  
Method ..... Fixed Time with Standard  
Calculation formula .....  $C = F * ( |A_{S,0} - A_{S,1}| - |A_{RB,0} - A_{RB,1}| )$   
Resulting factor .....  $F = C_{ST} / ( |A_{ST,0}-A_{ST,1}| - |A_{RB,0}-A_{RB,1}| )$   
Reagent blank .....entering or measuring

PHOTOMETER 5010 #30001 V9.Xa dd/mm/yy D LAB.: RIELE BERLIN USER 1: M.MUSTERMANN DATE: 09/03/25 TIME: 08:44:12 METHOD 30: CREATININ PROGRAM: 10 STANDARD: 2.00 WAVELENGTH: 492nm TEMPERATURE: 37C MEAS. VOLUME: 900u $\mu$ l WASH VOLUME: 1000u $\mu$ l INCUBATION: 45s REACTION: 60s MAX. UNITS: 25 UNIT: mg/dl ----- MEASURE ZERO Rb[A]: 0.000 DELTA Rb: 0.000 ST/KIN 1: 0.194 ST/KIN 2: 0.203 ST/KIN 3: 0.214 ST/KIN: 0.204 FACTOR: 9.80 NO. ABS. RESULT 1 0.326 9.84 DELTA [A]: 1.005 2 0.336 10.81 DELTA [A]: 1.103 3 0.329 12.84 DELTA [A]: 1.310	Start method selection in the main menu. See chapter: 4.1 - Measurement with programmed methods 4.2 - Measurement with basic methods In the case of activated printer the print-out of the method data follows. The measuring window is shown. Method procedure: →Insert / measure zero solution Without reagent blank (insert / measure optionally) →Insert / measure standard 1 →Insert / measure standard 2 (optional) →Insert / measure standard 3 (optional) (Averaged standard) (Resulting factor) →Insert / measure sample →Insert / measure sample →Insert / measure sample
--	---

### 5.4.11 Calculation procedure 11 (KIN/F/Rb)

Method at which a sample S is measured several times (depending on the number of deltas) in an equidistant time grid. From the resulting absorbance values an alteration per minute  $\Delta A_{S,Minute}$  is determined by a linear regression calculation. The reagent blank  $\Delta A_{RB,Minute}$  is measured in the same way as the sample (or entered directly in U/l) and subtracted from the sample value. This difference is multiplied by a given factor F. When running a kinetic test with decreasing absorbance the factor F should be minus signed (e.g.  $F = -1746$ ) in order to get a positive result. The factor F should be positive for tests with increasing absorbance.

During the procedure the dialog asks for the use of a reagent blank. The default value is OFF. To continue without reagent blank press [ENTER].

Calculation procedure ..... CP 11  
 Characteristic ..... KIN / F / Rb  
 Method ..... Kinetic with Factor  
 Calculation formula .....  $C = F * (\Delta A_{S,Minute} - \Delta A_{RB,Minute})$   
 Factor ..... given / entering  
 Reagent blank ..... entering or measuring  
 Number of deltas ..... entering (3 to 19)  
 Time per delta ..... entering (4 s to 255 s)

<p>PHOTOMETER 5010 #30001            V9.Xa dd/mm/yy D            LAB.: RIELE BERLIN            USER 1: M.MUSTERMANN            DATE: 09/03/25            TIME: 08:44:12            METHOD 31: GOT            PROGRAM: 11            FACTOR: - 1746            WAVELENGTH: 340nm            TEMPERATURE: 37C            MEAS. VOLUME: 900u<math>\ell</math>            WASH VOLUME: 1000u<math>\ell</math>            DELAY: 60s            DELTAS: 10            TIME/DELTA: 6s            MAX.UNITS: 280            MIN.R^2: 0.998            UNIT: U/l</p> <p>-----            MEASURE ZERO</p> <p>Rb[A]: 0.000            DELTA Rb: 0.000            R^2: 0.9762</p> <table border="1"> <thead> <tr> <th>NO.</th> <th>ABS.</th> <th>RESULT</th> </tr> </thead> <tbody> <tr> <td>1</td> <td>0.123</td> <td>189</td> </tr> <tr> <td></td> <td>R^2:</td> <td>0.9996</td> </tr> <tr> <td>2</td> <td>0.154</td> <td>189</td> </tr> <tr> <td></td> <td>R^2:</td> <td>0.9993</td> </tr> <tr> <td>3</td> <td>0.209</td> <td>96</td> </tr> <tr> <td></td> <td>R^2:</td> <td>1.0000</td> </tr> </tbody> </table>	NO.	ABS.	RESULT	1	0.123	189		R^2:	0.9996	2	0.154	189		R^2:	0.9993	3	0.209	96		R^2:	1.0000	<p>Start method selection in the main menu.            See chapter:            4.1 - Measurement with programmed methods            4.2 - Measurement with basic methods</p> <p>In the case of activated printer the print-out of the method data follows.</p> <p>The measuring window is shown.</p> <p>This example shows a negative factor producing a positive result at decreasing absorbance.</p> <p>The absorbance value will be constantly refreshed on the display during the delay time.            At the beginning and at the end of the delay time, the absorbance values ABS.1 and ABS.2 are measured respectively.</p> <p>Method procedure:</p> <p>→Insert / measure zero solution</p> <p>Without reagent blank (insert / measure optionally)</p> <p>→Insert / measure sample            Numerator /  ABS.1 – ABS.2  / Result            R^2: coefficient of determination, used for linearity control of the test (see chapter 5.1.7 Fundamental to the Kinetic...).</p> <p>→Insert / measure sample</p> <p>→Insert / measure sample</p> <p>A detail print-out of ABS.1, ABS.2 and deltas can be made after each measurement with [MODE] [MODE] [INFO] (see chapter 5.1.7 Fundamental to the Kinetic...).</p>
NO.	ABS.	RESULT																				
1	0.123	189																				
	R^2:	0.9996																				
2	0.154	189																				
	R^2:	0.9993																				
3	0.209	96																				
	R^2:	1.0000																				

### 5.4.12 Calculation procedure 12 (KIN/S/Rb)

Method at which a sample S is measured several times (depending on the number of deltas) in an equidistant time grid. From the resulting absorbance values an alteration per minute  $\Delta A_{S,Minute}$  is determined by a linear regression calculation. The reagent blank  $\Delta A_{RB,Minute}$  is measured in the same way as the sample (or entered directly in U/I) and subtracted from the sample value. This difference is multiplied by a factor F which is determined by measuring of a standard solution  $\Delta A_{ST,Minute}$  with known concentration  $C_{ST}$  and under consideration of the reagent blank  $\Delta A_{RB,Minute}$ .

During the procedure the dialog asks for the use of a reagent blank. The default value is OFF. To continue without reagent blank press [ENTER].

Calculation procedure .....CP 12  
 Characteristic .....KIN / S / Rb  
 Method .....Kinetic with Standard  
 Calculation formula .....  $C = F * (\Delta A_{S,Minute} - \Delta A_{RB,Minute})$   
 Resulting factor .....  $F = C_{ST} / (\Delta A_{ST,Minute} - \Delta A_{RB,Minute})$   
 Reagent blank .....entering or measuring  
 Number of deltas ..... entering (3 to 19)  
 Time per delta .....entering (4 s to 255 s)

<p>PHOTOMETER 5010 #30001            V9.Xa dd/mm/yy D            LAB.: RIELE BERLIN            USER 1: M.MUSTERMANN            DATE: 09/03/25            TIME: 08:44:12            METHOD 32: UREA            PROGRAM: 12            STANDARD: 100.0            WAVELENGTH: 340nm            TEMPERATURE: 37C            MEAS. VOLUME: 900uL            WASH VOLUME: 1000uL            DELAY: 5s            DELTAS: 5            TIME/DELTA: 8s            MIN.R^2: 0.998            UNIT: mg/dl</p> <p>-----            MEASURE ZERO</p> <p>Rb[A]: 0.000            Rb/KIN: 0.000            R^2: 0.1973</p> <p>ST/KIN 1: 0.327            R^2: 0.9996            ST/KIN 2: 0.330            R^2: 0.9989            ST/KIN 3: 0.324            R^2: 0.9994            ST/KIN: 0.327            FACTOR: 244.3</p> <table border="1"> <thead> <tr> <th>NO.</th> <th>ABS.</th> <th>RESULT</th> </tr> </thead> <tbody> <tr> <td>1</td> <td>0.232</td> <td>41.5</td> </tr> <tr> <td></td> <td>R^2:</td> <td>0.9984</td> </tr> <tr> <td>2</td> <td>0.175</td> <td>81.8</td> </tr> <tr> <td></td> <td>R^2:</td> <td>0.9997</td> </tr> </tbody> </table>	NO.	ABS.	RESULT	1	0.232	41.5		R^2:	0.9984	2	0.175	81.8		R^2:	0.9997	<p>Start method selection in the main menu.            See chapter:            4.1 - Measurement with programmed methods            4.2 - Measurement with basic methods</p> <p>In the case of activated printer the print-out of the method data follows.</p> <p>The measuring window is shown.</p> <p>The absorbance value will be constantly refreshed on the display during the delay time.            At the beginning and at the end of the delay time, the absorbance values ABS.1 and ABS.2 are measured respectively.</p> <p>Method procedure:</p> <p>→Insert / measure zero solution</p> <p>Without reagent blank (insert / measure optionally)</p> <p>→Insert / measure standard 1</p> <p>→Insert / measure standard 2 (optional)</p> <p>→Insert / measure standard 3 (optional)</p> <p>(Averaged standard)            (Resulting factor)</p> <p>→Insert / measure sample            Numerator /  ABS.1 – ABS.2  / Result            R^2: coefficient of determination, used for linearity control of the test (see chapter 5.1.7 Fundamental to the Kinetic...).</p> <p>→Insert / measure sample</p> <p>A detail print-out of ABS.1, ABS.2 and deltas can be made after each measurement with [MODE] [MODE] [INFO] (see chapter 5.1.7 Fundamental to the Kinetic...).</p>
NO.	ABS.	RESULT														
1	0.232	41.5														
	R^2:	0.9984														
2	0.175	81.8														
	R^2:	0.9997														

**5.4.13 Calculation procedure 13 (TRANSMISSION)**

Calculation procedure .....CP 13  
 Characteristic ..... T in %

<p>PHOTOMETER 5010 #30001  V9.Xa dd/mm/yy D  LAB.: RIELE BERLIN  USER 1: M.MUSTERMANN  DATE: 09/03/25  TIME: 08:44:12  METHOD 13: TRANSM.  PROGRAM: 13  FACTOR: 1.0  WAVELENGTH: 546nm  TEMPERATURE: 37C  MEAS. VOLUME: 900u<math>\text{l}</math>  WASH VOLUME: 1000u<math>\text{l}</math>  DELAY: 2s  UNIT: %</p> <p>MEASURE 100%</p> <table border="1"> <thead> <tr> <th>NO.</th> <th>ABS.</th> <th>RESULT</th> </tr> </thead> <tbody> <tr> <td>1</td> <td>0.329</td> <td>46.9</td> </tr> <tr> <td>2</td> <td>1.004</td> <td>9.9</td> </tr> <tr> <td>3</td> <td>2.020</td> <td>1.0</td> </tr> </tbody> </table>	NO.	ABS.	RESULT	1	0.329	46.9	2	1.004	9.9	3	2.020	1.0	<p>Start method selection in the main menu.  See chapter:  4.1 - Measurement with programmed methods  4.2 - Measurement with basic methods</p> <p>In the case of activated printer the print-out of the method data follows.</p> <p>The measuring window is shown.</p> <p>Method procedure:  →Insert / measure zero solution</p> <p>→Insert / measure sample  →Insert / measure sample  →Insert / measure sample</p>
NO.	ABS.	RESULT											
1	0.329	46.9											
2	1.004	9.9											
3	2.020	1.0											

#### 5.4.14 Calculation procedure 14 (C/F Delta)

Method at which a difference of sample  $E_2 - E_1$  is measured several times depending on the quantity of samples. In the first course the samples  $E_1$  (maximum 25) will be measured, optionally with or without sample blank. After a user defined measure time the samples  $E_2$  will be measured in a second course. Attention should be paid to the order within the series to avoid errors. The procedure corresponds to a fixed time kinetic and can only be processed using standard cuvettes.

Quality control samples cannot be saved.

This calculation procedure has special parameters that allow a time controlled measuring process. These parameters are: time/delta  $T_1$ , measure time  $T_2$ , delay  $T_3$ , reagent time #2 and reagent time #3. By setting a time/delta (value between 10s and 255s) the other parameters for the time controlled measuring will be used. In the time controlled mode the quantity of samples is determined by the measure time and the time/delta, e.g. with a measure time of 60s and a time/delta of 10s it is possible to measure 6 samples (without sample blank). The measure time should be chosen greater than or equal to the time/delta.

At the beginning of the method the use of a sample blank is queried.

After the blank is measured the time controlled measuring process will be started with [RESULT]. With a combination of acoustic signals and text messages on the display the Photometer takes control of the timing for the whole measuring. The measurement of the samples  $E_1$  can be finished at any time with [E1/E2]. In the second course will be so many samples measured as in the first course.

Before starting a new  $E_1/E_2$  course a new zero measurement has to be done.

The reagent time #3 is usable only if the reagent time #2 is set. In that case the reagent mode will be entered, i.e. the photometer also takes control of the timing for dispensing the reagent before measuring the samples. The quantity of samples will be determined by the reagent time #2 and the time/delta. The reagent time #2 should be chosen less than or equal to the reagent time #3 and greater than or equal to the time/delta.

Figure 5.4.14.1 shows the time sequence of a time controlled measuring process with  $N$  samples, a delay time  $T_3$  and without reagent time.

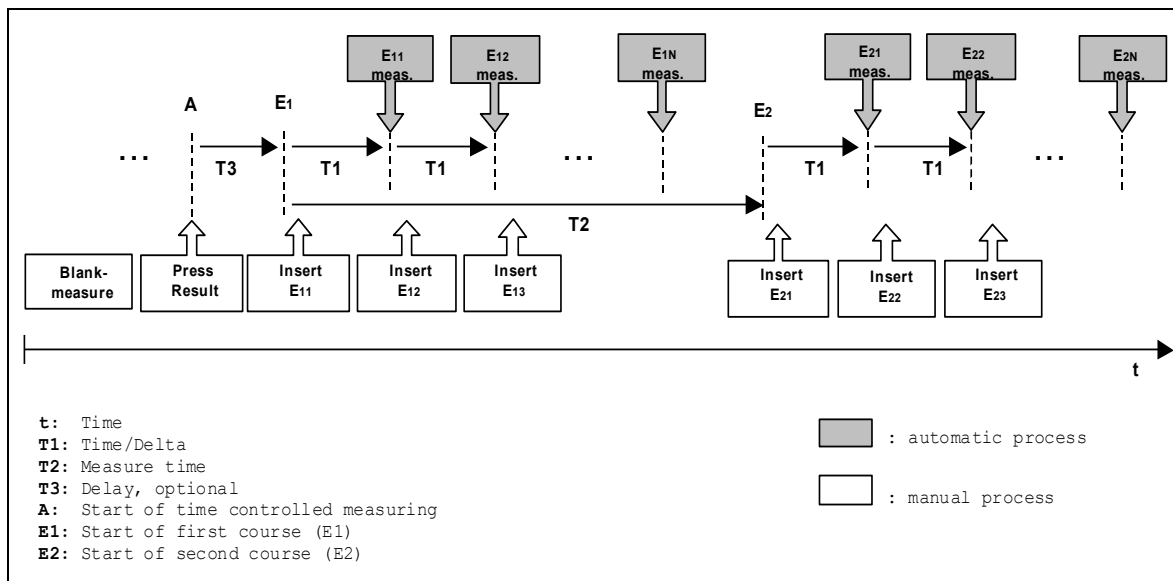

Fig. 5.4.14.1: time controlled measuring

Calculation procedure ..... CP 14  
 Characteristic ..... C / F / Delta  
 Method ..... Difference with Factor  
 Calculation formula .....  $C = F * (\Delta A_{S2-Sb2} - \Delta A_{S1-Sb1})$   
 Factor ..... given / entering  
 Sample blank ..... with / without  
 Time / Delta T1 ..... entering (0, 10s to 255s)  
 Measure time T2 ..... entering (0 to 1800s)  
 Delay T3 ..... entering (0 to 1800s)  
 Reagent time #2 ..... entering (0 to 1800s)  
 Reagent time #3 ..... entering (0 to 1800s)

<p>PHOTOMETER 5010 #30001                  V9.Xa dd/mm/yy D                  LAB.: RIELE BERLIN                  USER 1: M.MUSTERMANN                  DATE: 09/03/25                  TIME: 08:44:12                  METHOD 14: C/F DELTA                  PROGRAM: 14                  FACTOR: 1.000                  WAVELENGTH: 405nm                  TEMPERATURE: 37C                  TIME/DELTA: 12s                  MEASURE TIME: 100s                  DELAY: 10s                  REAGENT 2: 40s                  REAGENT 3: 60s                  UNIT: U/l</p> <p>-----                  MEASURE ZERO</p> <table border="0"> <tr><td>NO.</td><td>Sb[A]</td><td>S[A]E1</td></tr> <tr><td>1</td><td>0.083</td><td>0.411</td></tr> <tr><td>2</td><td>0.110</td><td>0.382</td></tr> <tr><td>3</td><td>0.146</td><td>0.492</td></tr> </table> <table border="0"> <tr><td>NO.</td><td>Sb[A]</td><td>S[A]E2</td></tr> <tr><td>1</td><td>0.091</td><td>1.090</td></tr> <tr><td>2</td><td>0.140</td><td>0.991</td></tr> <tr><td>3</td><td>0.200</td><td>1.165</td></tr> </table> <table border="0"> <tr><td>NO.</td><td>RESULT</td></tr> <tr><td>1</td><td>0.671</td></tr> <tr><td>2</td><td>0.578</td></tr> <tr><td>3</td><td>0.619</td></tr> </table> <table border="0"> <tr><td>NO.</td><td>Sb[A]</td><td>S[A]E1</td></tr> <tr><td>1</td><td>0.000</td><td>1.012</td></tr> <tr><td>2</td><td>0.000</td><td>1.138</td></tr> <tr><td>3</td><td>0.000</td><td>1.076</td></tr> </table> <table border="0"> <tr><td>NO.</td><td>Sb[A]</td><td>S[A]E2</td></tr> <tr><td>1</td><td>0.000</td><td>1.458</td></tr> <tr><td>2</td><td>0.000</td><td>1.530</td></tr> <tr><td>3</td><td>0.000</td><td>1.384</td></tr> </table> <table border="0"> <tr><td>NO.</td><td>RESULT</td></tr> <tr><td>1</td><td>0.446</td></tr> <tr><td>2</td><td>0.392</td></tr> <tr><td>3</td><td>0.307</td></tr> </table>	NO.	Sb[A]	S[A]E1	1	0.083	0.411	2	0.110	0.382	3	0.146	0.492	NO.	Sb[A]	S[A]E2	1	0.091	1.090	2	0.140	0.991	3	0.200	1.165	NO.	RESULT	1	0.671	2	0.578	3	0.619	NO.	Sb[A]	S[A]E1	1	0.000	1.012	2	0.000	1.138	3	0.000	1.076	NO.	Sb[A]	S[A]E2	1	0.000	1.458	2	0.000	1.530	3	0.000	1.384	NO.	RESULT	1	0.446	2	0.392	3	0.307	<p>Start method selection in the main menu.                  See chapter:                  4.1 - Measurement with programmed methods                  4.2 - Measurement with basic methods</p> <p>In the case of activated printer the print out of the method data follows.</p> <p>The measuring window is shown.</p> <p><b>Method procedure with sample blank:</b></p> <p>→Insert / measure zero solution</p> <p>→Measure all samples E1 (maximum 25)</p> <p>→Change to measuring E2 by [E1/E2]</p> <p>→Measure all samples E2 (maximum 25)</p> <p>Results based on the differences of the measured samples</p> <p>→Show the results by [MODE] [MODE] [INFO]</p> <p><b>Method procedure without sample blank:</b></p> <p>→Measure all samples E1 (maximum 25)</p> <p>→Change to measuring E2 by [E1/E2]</p> <p>→Measure all samples E2 (maximum 25)</p> <p>Results based on the differences of the measured samples</p> <p>→Show the results by [MODE] [MODE] [INFO]</p>
NO.	Sb[A]	S[A]E1																																																															
1	0.083	0.411																																																															
2	0.110	0.382																																																															
3	0.146	0.492																																																															
NO.	Sb[A]	S[A]E2																																																															
1	0.091	1.090																																																															
2	0.140	0.991																																																															
3	0.200	1.165																																																															
NO.	RESULT																																																																
1	0.671																																																																
2	0.578																																																																
3	0.619																																																																
NO.	Sb[A]	S[A]E1																																																															
1	0.000	1.012																																																															
2	0.000	1.138																																																															
3	0.000	1.076																																																															
NO.	Sb[A]	S[A]E2																																																															
1	0.000	1.458																																																															
2	0.000	1.530																																																															
3	0.000	1.384																																																															
NO.	RESULT																																																																
1	0.446																																																																
2	0.392																																																																
3	0.307																																																																

**5.4.15 Calculation Procedure 15 (C/F 3 WL)**

Method at which a sample is measured with three different wavelengths: 380 nm, 415 nm and 450 nm. This method is appropriated for free hemoglobin measurements.

The wavelength 380 nm is only available in combination with a halogen lamp optic. Please contact the manufacturer for further details.

The mentioned wavelengths are not included in the standard set of filters.

The factor has to be adjusted if using thinner (see chapter 5.1.3).

Calculation procedure ..... CP 15  
 Characteristic ..... C / F 3 WL  
 Method ..... Measurement with 3 wavelengths  
 Calculation formula .....  $C [mg/dl] = F * (168 * A_{415nm} - 84 * A_{380nm} - 84 * A_{450nm})$   
 Factor ..... given / entering  
 Conversion factor .....  $\mu mol/L \equiv 0,6206 * mg / dl$

<p>PHOTOMETER 5010 #30001                  V9.Xa dd/mm/yy D                  LAB.: RIELE BERLIN                  USER 1: M.MUSTERMANN                  DATE: 09/03/25                  TIME: 08:44:12                  METHOD 15: C/F 3 WL                  PROGRAM: 15                  FACTOR: 1.00                  WAVELENGTH:                  380/415/450nm                  TEMPERATURE: 37C                  DELAY: 2s                  UNIT: mg/dl                  - - - - -                  MEASURE ZERO                  NO. <math>\mu mol/L</math> mg/dl                  1 4.859 7.83                  2 5.865 9.45</p>	<p>Start method selection in the main menu.                  See chapter:                  4.1 - Measurement with programmed methods                  4.2 - Measurement with basic methods</p> <p>In the case of activated printer the print out of the method data follows.</p> <p>The measuring window is shown.</p> <p>→Insert / measure zero solution</p> <p>→The result will be displayed in two units of measurement</p> <p>→Insert / measure sample</p>
--	--

### 5.4.16 Calculation Procedure 16 (DELTA R1R2)

Method for two endpoint assays to calculate the difference in absorbance (E1 and E2) after addition of two reagents R1 and R2 to a sample. E1 represents the absorbance of a sample in addition with reagent 1 (R1) just before a second reagent (R2) is added. E2 is the absorbance after adding R2. The course of the procedure is outlined in Fig. 5.4.16.1.

The maximum number of samples depends on the length of the measure time of reagent 1 and 2 (T2 and T3). The number of samples may be reduced by pushing [->R2] before starting the measurement or by skipping of further samples during the first pipetting phase.

During the procedure the user is guided by indications on the screen (draw up and dispense reagent, etc., see Fig. 5.4.16.2) and acoustic signals.

The factor  $F_{dil}$  is the volume correction factor which is calculated on the basis of the given volumes (sample volume (a), R1 volume (b) and R2 volume (c) on page 3/3 of the method parameters). The factor is set to 1.000 by default when given volumes are not set.

$$\Delta A_s = E_2 - F_{dil} * E_1$$

whereby  $F_{dil} = (a + b) / (a + b + c)$

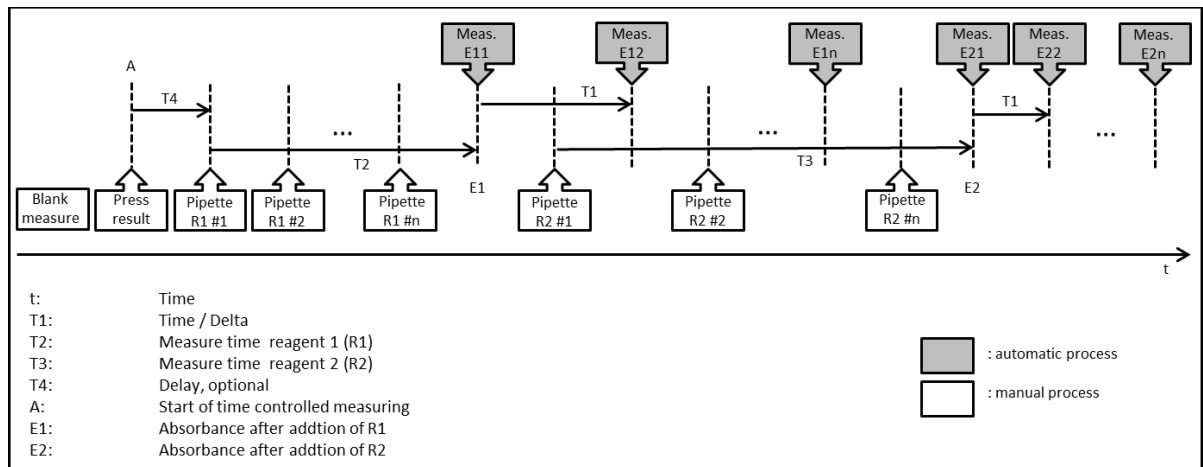

Fig. 5.4.16.1: time controlled measuring

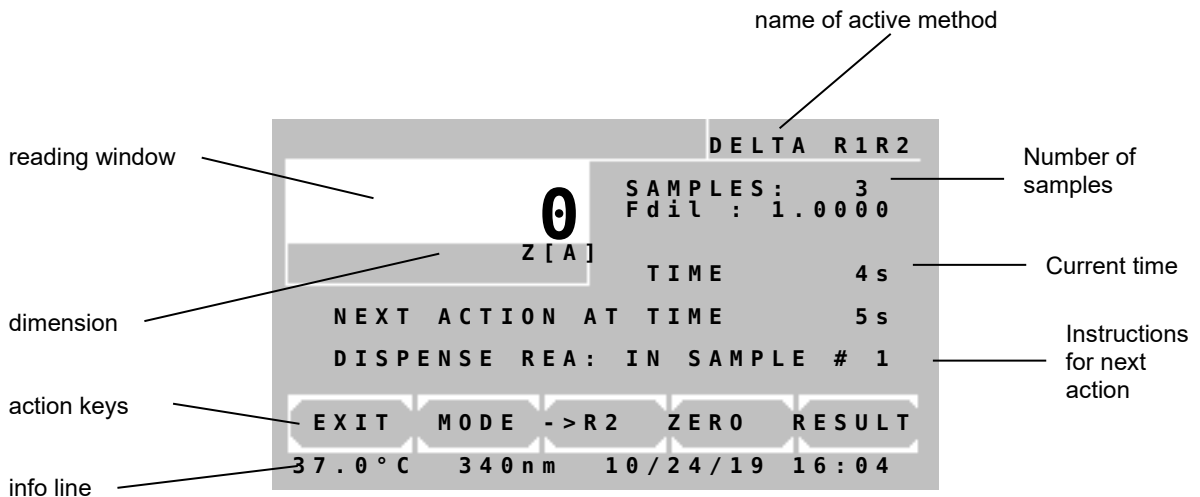

Fig. 5.4.16.2: screen during the method

Calculation procedure .....CP 16  
 Characteristic .....DELTA R1R2  
 Method ..... Difference measurement of two reagents  
 Calculation formula .....C =  $\Delta A_s$   
 Factor ..... given / entering  
 Time / Delta T1 .....entering (20 to 255s)  
 Measure time R1 T2 .....entering (0 to 1800s)  
 Measure time R2 T3 .....entering (0 to 1800s)  
 Delay T4 .....entering (0 to 1800s)

<pre> PHOTOMETER 5010 #30001 V9.Xa dd/mm/yy D LAB.: RIELE BERLIN USER 1: M.MUSTERMANN DATE: 09/03/25 TIME: 08:44:12 METHOD 20: DELTA R1R2 PROGRAM: 16 FACTOR: 1.000 WAVELENGTH: 546nm TEMPERATURE: 37C TIME/DELTA: 30s DELAY: 0s TIME REA.#1 130s TIME REA.#2 130s UNIT: - - - - - MEASURE ZERO  E1 1 0.285 [A] E1 2 0.285 [A] E1 3 0.285 [A] E2 1 0.165 [A] E2 2 0.165 [A] E2 3 0.165 [A]  NO. RESULT 1 -0.116 2 -0.116 3 -0.116                 </pre>	<p>Start method selection in the main menu.                  See chapter:                  4.1 - Measurement with programmed methods                  4.2 - Measurement with basic methods</p> <p>In the case of activated printer the print out of the method data follows.</p> <p>The measuring window is shown.</p> <p>→Insert / measure zero solution</p> <p>→Insert / measure samples with reagent 1</p> <p>→Insert / measure samples with reagent 2</p> <p>The user is guided through the measuring procedure on the screen.</p> <p>→The result will be displayed</p>
--	---

## 6 METHOD EDITOR

By the method editor the daily laboratory work can be substantially facilitated. Based on the 15 calculation procedures up to 231 user-defined methods with their setting parameters can be saved. With the functions of the editor a method can be established, changed or deleted.

**Fig. 6.1**

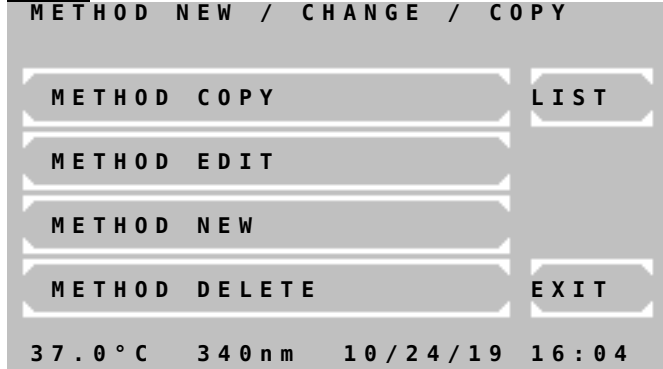

In the main window of the method editor following options are available:

[METHOD COPY] Change to [Fig. 6.2](#), where different copy functions can be selected.

[METH. EDIT] Change to [Fig. 6.3](#), where the number of the method to be edited is queried. Afterwards all setting parameters of the selected method can be changed.

[METHOD NEW] Change to selection of the calculation procedure (see 5.3 SURVEY OF THE METHODS). In [Fig. 6.4](#) all setting parameters can be edited.

[METHODE DELETE] Change to [Fig. 6.3](#), where the number of the method to be deleted is queried. After a prompt for confirmation the selected method is deleted. (Basic and fixed methods cannot be deleted).

[LIST] A list of all programmed methods can be printed and transmitted via the serial interface.

[EXIT] Return to main menu

Print-out of a method list:

```
METHOD 20: HEMOGLOBIN
F 29.4 405nm g/dl

METHOD 21: HDL-C
F 1.000 546nm mg/dl

METHOD 30: CREATININ
S 2.0 492nm mg/dl

METHOD 31: GOT
F-1746.0 340nm U/l
```

**Fig. 6.2**

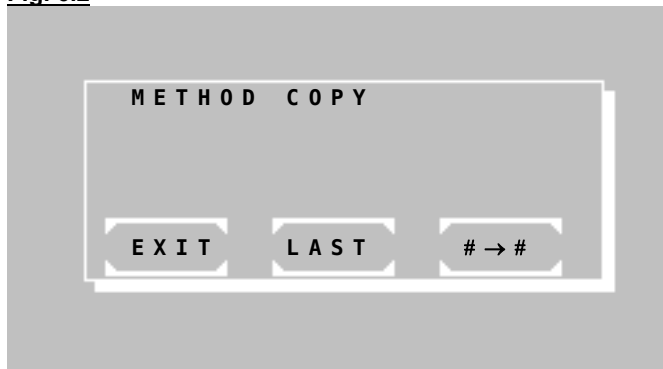

[#->#] All methods from no 20 can be copied to a new method no. First the method to be copied is queried in [Fig. 6.3](#). Its parameters can be changed starting with [Fig. 6.4](#).

[LAST] The method used last can be copied on a new method place. Its setting parameters can be changed starting with [Fig. 6.4](#).

This function is very useful if a basic method with new setting parameters was successfully tested. These parameters can be saved as a new method starting from no 20.

[EXIT] Return to main menu

Fig. 6.3

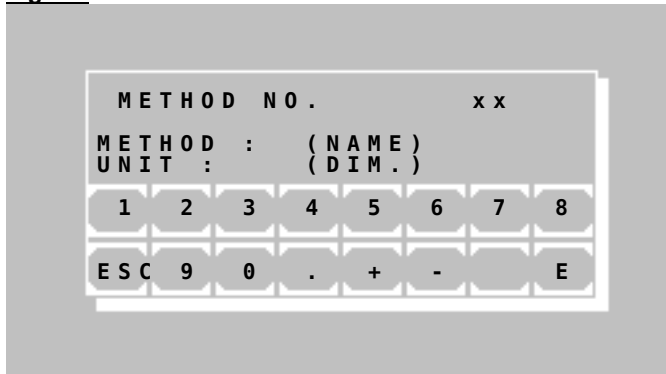

Inquiry window of the desired method.

The method used last is suggested. With [+] or [-] the methods can be scrolled. A numeric input (xx) of the method number is possible at any time. A known method is indicated with name and dimension.

[E] Select shown method

[ESC] Return to main menu

Fig. 6.4 (parameter window 1)

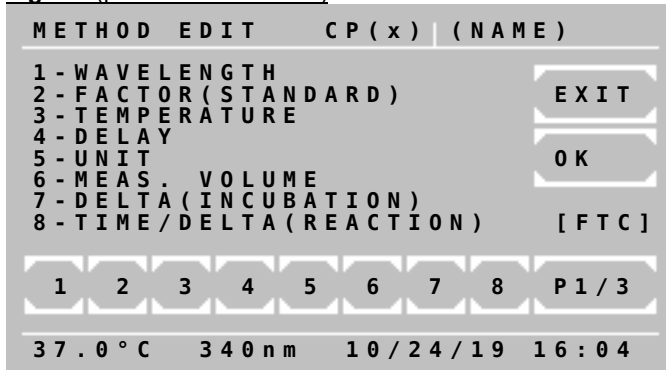

The parameter windows 1 and 2 show the general method data.

The parameter window 3 has special functions which are necessary for quality control only (see below).

For each setting parameter a leading identification number is shown. If the identification number is selected on the keyboard, the corresponding setting parameter becomes configurable.

Number and kind of setting parameters depend on the calculation procedure. So identification numbers can be occupied variedly. Characteristic numbers without parameters do not have a function.

Fig. 6.5 (parameter window 2)

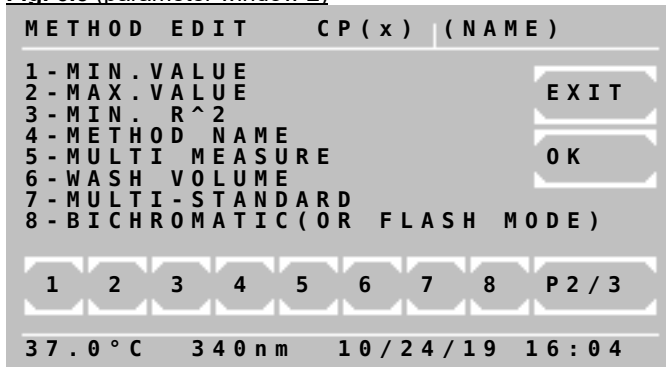

[EXIT] Return to main menu

[OK] Accept setting parameters (depending on editor mode sometimes with query of target method)

[S-CUV.] or [FTC] selects the respective cuvette system used during the method.

[P../3] Change to next parameter window

8 - FLASH MODE ON: For kinetics and fixed time kinetics the LED is turned on just before the measurement to avoid heating effects.

Fig. 6.6 (parameter window 3)

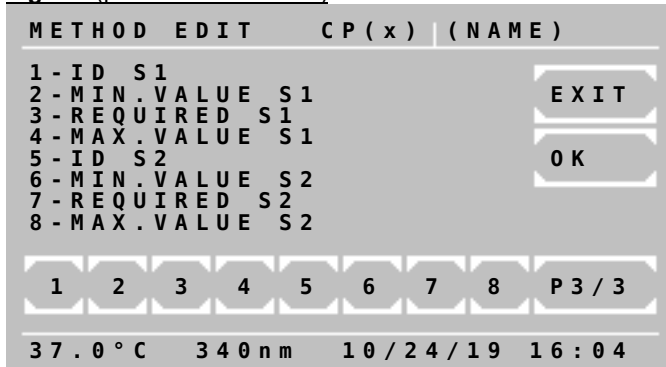

#### Specifics in parameter window 3:

At least one control serum must be defined, before data can be entered (see chapter 7.2.6 Quality control).

If at least one control serum with its setpoint and range is entered, corresponding memory of the quality control is reserved for this method. So it can be supervised with integrated quality control.

**i** If both ID identifications are deleted, then also all data and reserved memory of this method in the quality control are deleted!

**Fig. 6.7**

METHOD NO .							
NEXT FREE NO . xx							
1	2	3	4	5	6	7	8
ESC	9	0	.	+	-		E

Query of the desired method number, under which the new method is to be stored. The next free method number is indicated. However each free method number can be selected within the range of 20 to 250.

[E] Store method with selected number. In case of multi-standard method [Fig. 6.8](#) follows.

[ESC] Break storage and return to editor menu

**Fig. 6.8**

CURVE NO . xx							
P 1	A	-	0	0	0	0	NEW A
	C	-	0	0	0	0	
1	2	3	4	5	6	7	8
ESC	9	0	.	P+	P-	A/C	E

For a method with multi-standard there is the editor window for the curve bases.

[P+] and [P-] Consecutive numbering of the current bases

[A/C] Switch input between A for absorbance and C for concentration

[E] Accept the edited value



Input and confirmation of a single "0" at A lead to the deletion of the current pair of points. In order to set the value to zero enter e.g. "0.0".

[ESC] End input and save curve data



For measuring in a multi-standard method at least 2 bases with A and C must be defined!

## 7 UTILITY PROGRAMS

### 7.1 SELECTION OF UTILITY PROGRAMS

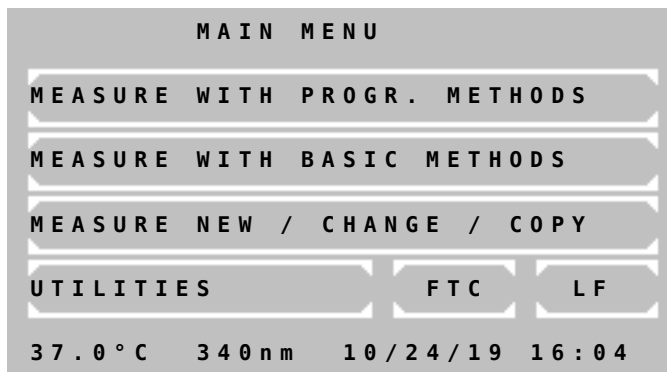

#### Main menu:

Utility programs are necessary for the adjustment and maintenance of the photometer.

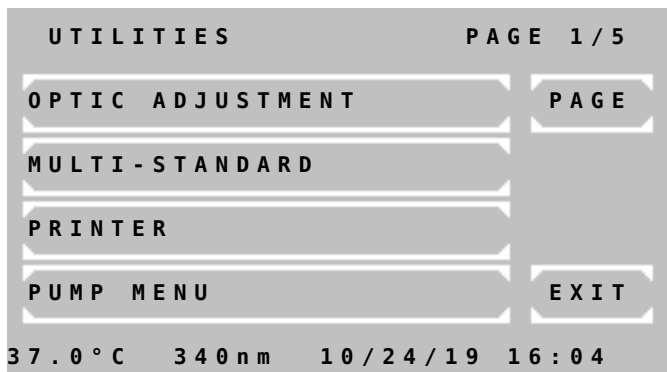

#### Page 1 of utility programs:

Scrolling through all utility programs is possible by [PAGE]. The current page is shown at the right upper screen corner. By [EXIT] the program returns to the main menu.

A utility program is selected by pressing the relating key.

Utilities	Description in chapter
Optic adjustment	7.2.1
Multi-standard functions	7.2.2
Printer ON / OFF	7.2.3
Pump menu	7.2.4
Menu serial com	7.2.5
Quality control	7.2.6
Settings printout	7.2.7
Stored results	7.2.8
Temperature ON / OFF	7.2.9
Temperature adjustment	7.2.10
Laboratory name	7.2.11
User name	7.2.12
Error list	7.2.13
Key signal ON / OFF	7.2.14
Touchscreen adjustment	7.2.15
Date / Time	7.2.16
Language	7.2.17
ADC counts (Optic)	7.2.18
Bar Code	7.2.19
Service tools	7.2.20

## 7.2 DESCRIPTION OF UTILITY PROGRAMS

### 7.2.1 Optic adjustment

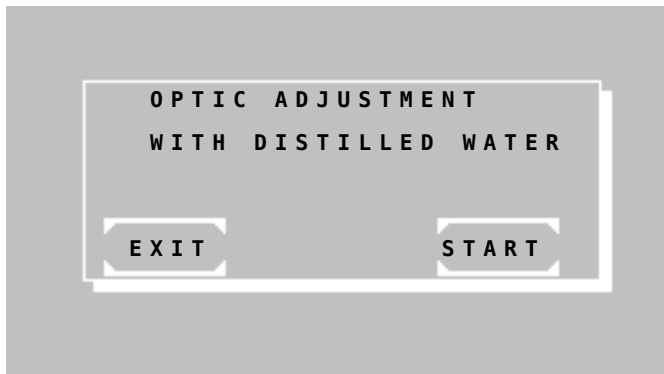

#### **In case of working with flow-through system, [FTC] selected:**

The optic adjustment should be done not before the warm-up time of 15 minutes has passed, better after one hour operation.

**i** Aspirate distilled water by [sipping lever P] before starting the procedure.

**i** The lid of the cuvette compartment may stay open. The optic is not sensitive to stray light.

Start the optic adjustment by [START].

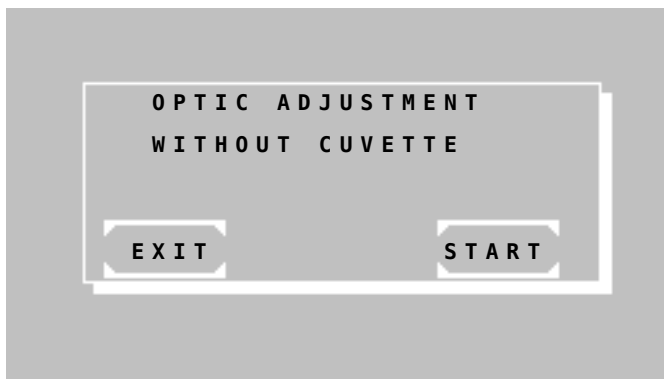

#### **In case of working with standard cuvette, [S-CUV.] selected:**

The optic adjustment should be done not before the warm-up time of 15 minutes has passed, better after one hour operation.

**i** Remove any cuvette from the cuvette compartment.

**i** The lid of the cuvette compartment may stay open. However, we recommend closing the lid to avoid stray light.

Start the optic adjustment by [START].



Calibration procedure:

Wait for about 40s until adjustment is finished.

The function cannot be interrupted. After completion the program returns to the utility program level.

**i** Monthly executed the optic adjustment compensates possible deviations of the measuring accuracy due to environmental influences.

## 7.2.2 Multi-standard functions

Before curve data of a method with multi-standard can be processed, the method must have been established in the method editor (chapter 6 - METHOD EDITOR). A curve without corresponding method cannot be processed! The term "curve no" has the same meaning as "method no".

If using a multi-standard method later on, pay attention that all extinction values of the samples lie within the range of the curve bases. Values outside of the extinction range cannot be calculated. In this case "+-" is shown and "<<< >>>" printed instead of the reading.

Fig. 7.2.2.1

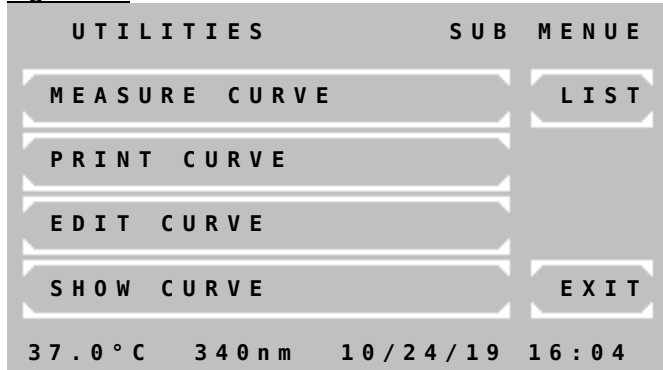

Main window of multi-standard functions

[MEASURE CURVE] After query of a curve number and the first standard the program changes automatically to the method selection window. There the given parameters of the respective method can be again controlled and/or changed. All further standards are queried during the following procedure.

The program for measuring the multi-standards branches out automatically to the calculation procedures as follows:

CP1 → CP5  
 CP2 → CP6  
 CP3 → CP7  
 CP4 → CP8  
 CP9 → CP10  
 CP11 → CP12  
 CP14 → CP14

Print-out of curve:

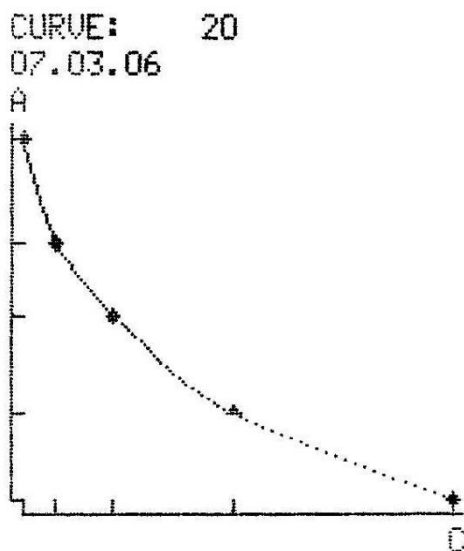

NO.	ABS.	CONC.
1	0.302	60
2	0.600	30
3	0.920	15
4	1.160	7.5
5	1.501	3.25

**i** For measuring in another standard method than suggested, start measuring multi-standards in each other selected standard method (before measuring the first standard) by [MODE] [MODE] [M-STD]. Curve number and standards are queried accordingly.

[MEASURE CURVE] After inquiry of a curve number start of measuring of standard directly with a basic method which is based on standard. This special mode ends automatically after measuring or after selection of a factor method. The standard of the selected basic method represents the first standard which can be measured. All further standards are queried during the measuring execution in the special mode.

[PRINT CURVE] After inquiry of the curve number print-out on the internal printer or via the serial interface.

**i** For measuring in a multi-standard method at least 2 bases with A and C must be defined!

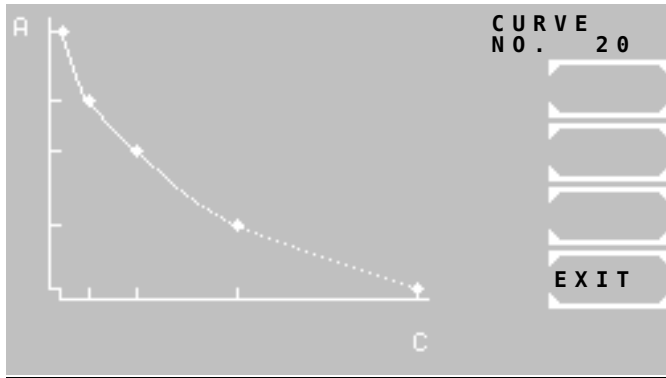

[EDIT CURVE] After inquiry of the curve number all curve bases can be edited (see fig. 7.2.2.2).

[SHOW CURVE] After inquiry of the curve number the function will be shown.

Fig. 7.2.2.2

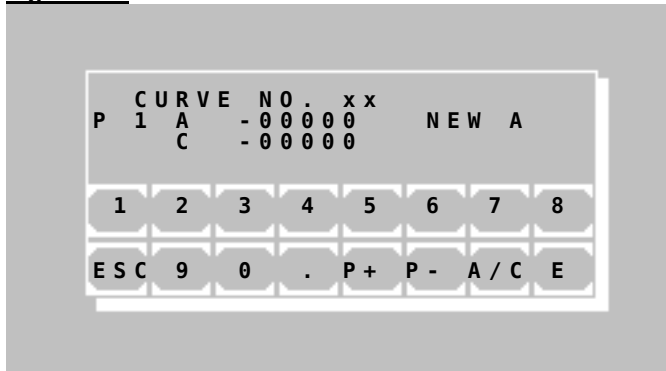

[LIST] The method number and the date of preparation of all current curves are shown.

[EXIT] Return to the utilities

[P+] and [P-] Consecutive numbering of the current bases

[A/C] Switch input between A for absorbance and C for concentration

[E] Accept the edited value

**i** Input and confirmation of a single "0" at A lead to the deletion of the current pair of points. In order to set the value to zero enter e.g. "0.0".

[ESC] End input and save curve data. The bases are sorted in ascending order according to their A value.

7.2.3 Printer ON / OFF

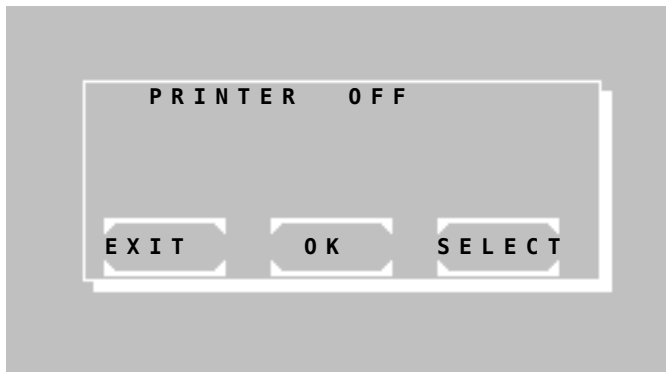

The current status of the internal printer is indicated in the first line by OFF or ON.

Change setting by [SELECT]

Save setting permanently by [OK]

Save setting temporarily up to next switch-off of the device by [EXIT]

NO.	ABS.	RESULT
1	0.675	19.8
TIME:		11:21:32

**i** When printer ON via [MODE] [PRN] after a measurement the current time can be printed out by [TIME].

## 7.2.4 Pump menu

With these functions the pump and the bubble detector can be checked and adjusted. The check and adjustment is possible only if [FTC] is selected in the main menu and the flow-through cuvette is inserted.

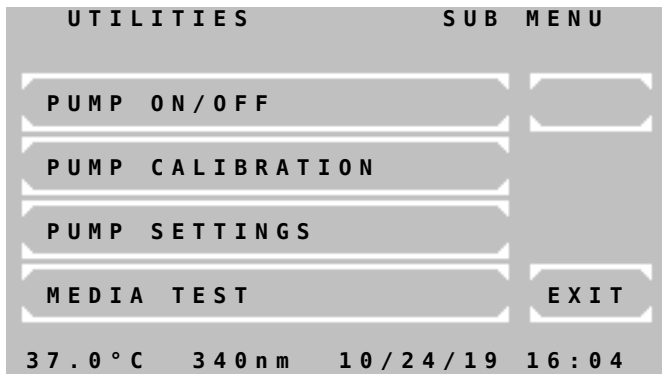

The menu offers following functions:

- Activation and deactivation of pump
- Calibration of pump volume
- Activation and deactivation of bubble detector and of the volume optimized mode.
- Media test: check and adjustment of bubble detector.

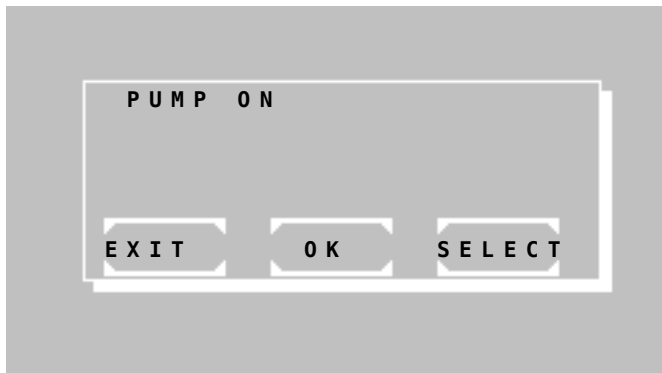

### 7.2.4.1 Pump ON / OFF

The status of the pump is indicated in the first line by OFF or ON.

The pump status is set automatically depending on which cuvette system is selected in the main menu:

[S-CUV.] pump is OFF  
[FTC] pump is ON

Change setting by [SELECT]

Save setting permanently by [OK]

Save setting temporarily up to next switch-off of the device by [EXIT]

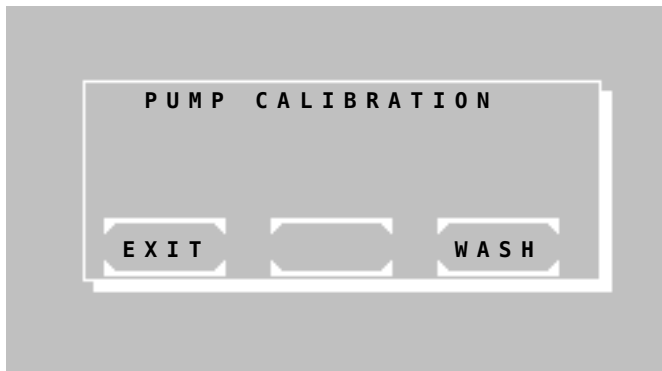

### 7.2.4.2 Pump calibration

The pump calibration can be executed with or without bubble detector. So set bubble detector ON or OFF (see chapter 7.2.4.3.1).

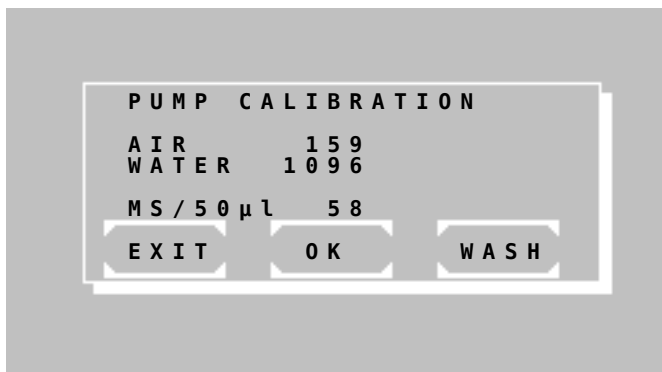

Behavior *with* bubble detector:

In preparation for the calibration first clean the system by [WASH]. The aspiration tubing must be empty before proceeding.

Pump exactly 1000 µl distilled water by [Sipping lever P].

When the pump has stopped, values for air and water are indicated which correspond to the delivered volumes.

Save setting permanently by [OK]

**i** If the calibration is not possible, although the pump tube is connected and 1000 µl were sucked in, execute a media test (see chapter 7.2.4.4). Afterwards the pump calibration can be repeated.

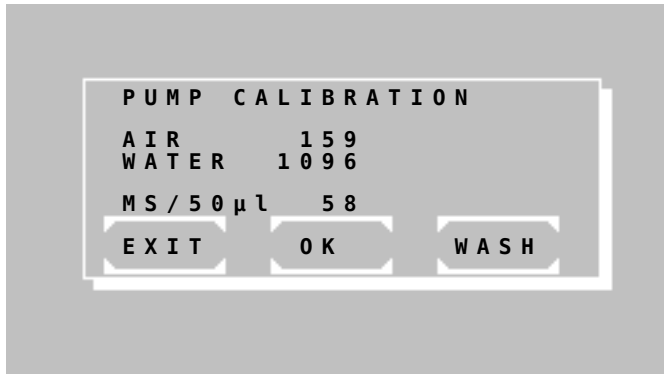

Behavior **without** bubble detector:

In preparation for the calibration first clean the system by [WASH]. The aspiration tubing must be empty before proceeding. Start to pump exactly 1000 µl distilled water by [Sipping lever P]. With each operation of [Sipping lever P] the pump wheel rotates and delivers air. As soon as the liquid in the tube can be seen between the metal inlet tube and the screw connection of the aspiration tube, confirm the event by [OK]. The turns are shown beside the entry AIR on the screen and represent the air path.

During the second phase the rest of the 1000 µl distilled water needs to be pumped by pushing [Sipping lever P] repeatedly. The turn of the pump wheel is shown beside the entry WATER. As soon as the end of the liquid in the tube between the metal inlet tube and the screw connection of the aspiration tube can be seen, confirm the event by [OK].

Save setting permanently by [OK]

#### **7.2.4.3 Pump settings**

In this menu it is described how to configure the bubble detector and the optimized volume mode.

After having configured the bubble detector the window for the configuration of the optimized volume mode will be displayed automatically.

##### **7.2.4.3.1 Bubble detector ON / OFF**

The current status of the bubble detector is indicated in the first line by OFF or ON.

Change setting by [SELECT]

Save setting permanently by [OK]

Save setting temporarily up to next switch-off of the device by [EXIT]

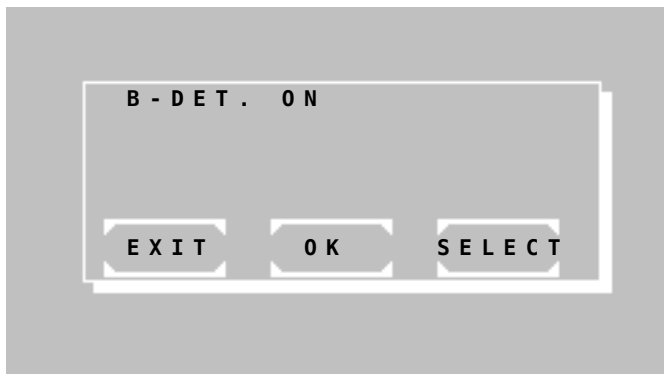

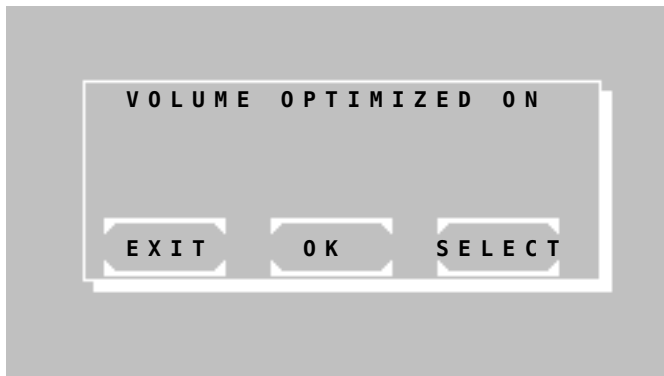

#### **7.2.4.3.2 Volume optimized ON / OFF**

The status of this setting is indicated in the first line by OFF or ON.

Change setting by [SELECT]

Save setting permanently by [OK]

Save setting temporarily up to next switch-off of the device by [EXIT].

When volume optimized is on, an acoustic signal will be emitted after the required volume is pumped. At this moment the sample must be retired from the aspiration tube. After a pause of approx. 1s the rest of liquid in the tube will be completely pumped into the flow through cuvette. For example, this function makes it possible to pump two consecutive times 500 µl from a 1000 µl sample volume.

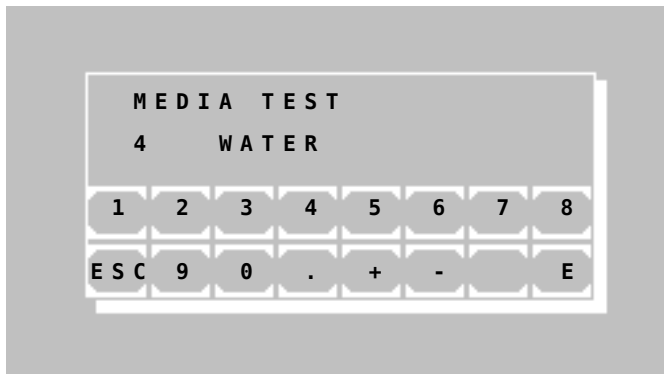

#### **7.2.4.4 Media test**

With the media test the bubble detector can be checked and adjusted.

In the second line to the left of the medium WATER the current sensitivity level of the bubble detector is shown.

Sip distilled water by [Sipping lever P]. Be sure that the aspiration tube is completely filled with water.

Enter new sensitivity level step by step by numeric key [0] up to [9], starting with 0, until the display changes from "AIR" to "WATER". Then increase the sensitivity level by one further step.

Empty the aspiration tube by [Sipping lever P]. The display changes from "WATER" to "AIR".

The adjustment is permanently saved by [E].

### 7.2.5 Menu serial com

A PC or an external printer can be connected to Photometer 5010 via the RS 232 serial interface at the back. A suitable data cable can be supplied (REF 501-002). The connected device must comply with safety standard EN 60950.

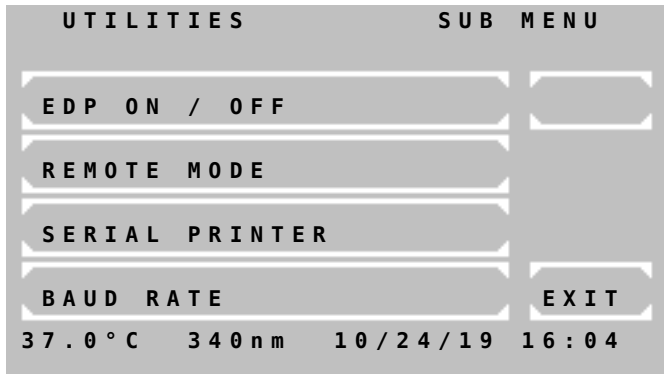

The menu offers following functions:

- Activation and deactivation of EDP
- Activation of remote control
- Activation or deactivation of external printer with serial interface
- Setting of baud rate

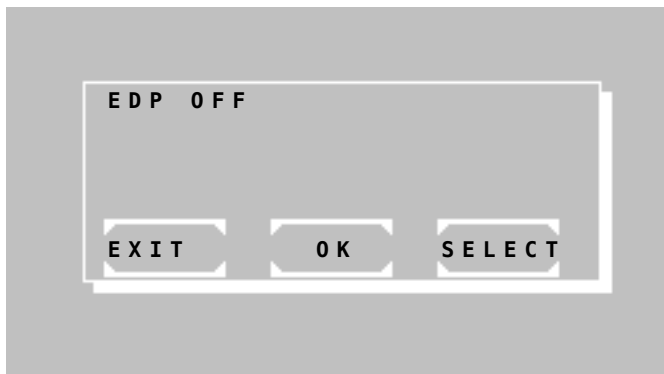

#### 7.2.5.1 EDP ON / OFF

The status of the EDP (Electronic Data Processing) interface is indicated in the first line by OFF or ON.

Change setting by [SELECT]:

- EDP OFF: no output,
- EDP ON (CR-LF): system output through serial port with CR-LF protocol,
- EDP ON (STX-ETX-BCC): system output through serial port with STX-ETX-BCC protocol,
- EDP ON (CR-LF-LOG): after each measurement a formatted string will be output through the serial port. (e.g. see table. 7.2.5.1)

Save setting permanently by [OK]

Save setting temporarily up to next switch-off of the device by [EXIT]

Table 7.2.5.1

Serial no.	Method no.	ID-no.	Sample no.	Result	Temperature control	User	Date	Time
11000	20	12345	1	15.5	*	[user name]	09/08/09	09:30:47

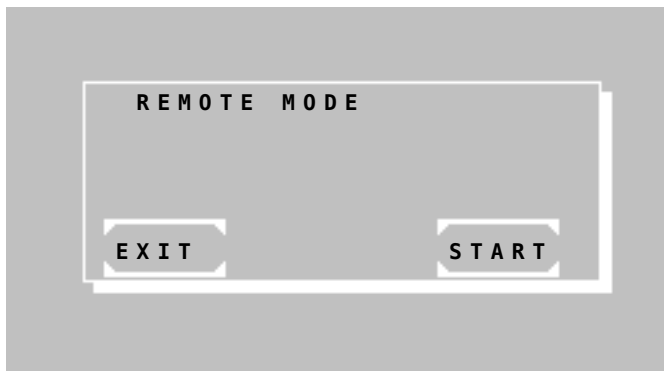

#### 7.2.5.2 REMOTE CONTROL

Activate remote control by [START].

When activated, Photometer 5010 can be remote-controlled by a PC and a suitable program.

Deactivate remote control by sipping lever [P].

By [EXIT] the program returns to the superordinate menu item.

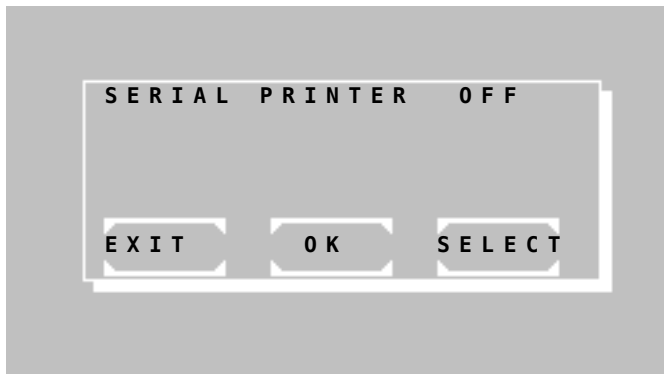

### 7.2.5.3 SERIAL PRINTER ON / OFF

The status of the external serial printer is indicated in the first line by OFF or ON.

Change setting by [SELECT]

Save setting permanently by [OK]

Save setting temporarily up to next switch-off of the device by [EXIT]

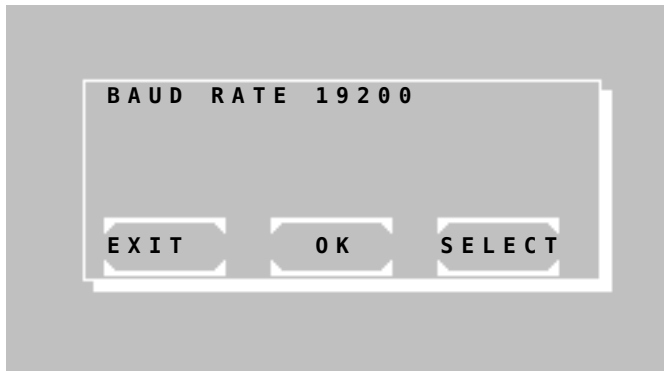

### 7.2.5.4 BAUD RATE

The current baud rate is shown in the first line.

Change setting by [SELECT].

Save setting permanently by [OK].

Discard changes by [EXIT].

## 7.2.6 Quality control

In Photometer 5010 up to 50 methods can be supervised with a quality control. The device can manage up to 6 control serums. Each QC supervised method can be connected with 2 control serums. The QC data of a series of measurements are stored in a daily memory. Each reading is stored with method number, date and user identification. From the daily memory the individual QC data can become deleted or saved in the monthly memory of the corresponding method. The monthly memory of a QC method can record up to 31 readings. With the 32nd the oldest reading is deleted in the memory. For the calculation of the quality values of a method at least 20 readings in the monthly memory must be present. The average of all readings, the standard deviation and the coefficient of variation are calculated. Contents of the daily and monthly memory can be indicated and printed out.

Except the basic methods all methods can be connected with a quality control. The method-typical data of a control serum are entered via the method editor (see chapter 6 METHOD EDITOR).

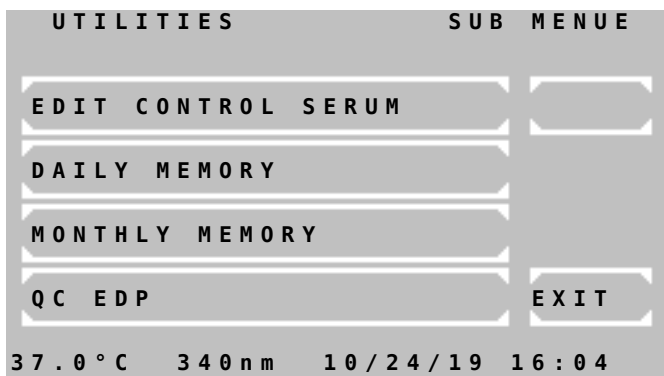

The QC menu offers following functions:

[EDIT CONTROL SERUM] Up to 6 control serums can be defined. Without a defined serum the QC cannot be started!

[DAILY MEMORY] View, print and processing of the daily memory for serum 1/2

[MONTHLY MEMORY] View, print and processing of the monthly memory for serum 1/2

[QC EDP] - not implemented -

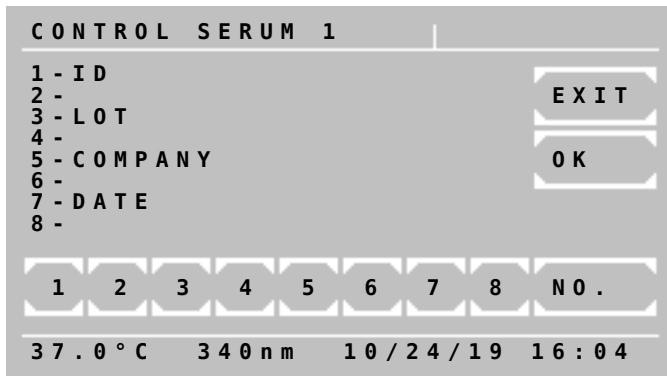

**7.2.6.1 INPUT OF CONTROL SERUM**

- [1] Enter name max 15-digit
- [3] Enter LOT no max 10-digit
- [5] Enter company max 10-digit
- [7] Enter expiry date max 8-digit
- [NO.] Change to next control serum
- [EXIT] and [OK] Accept input and return to QC menu

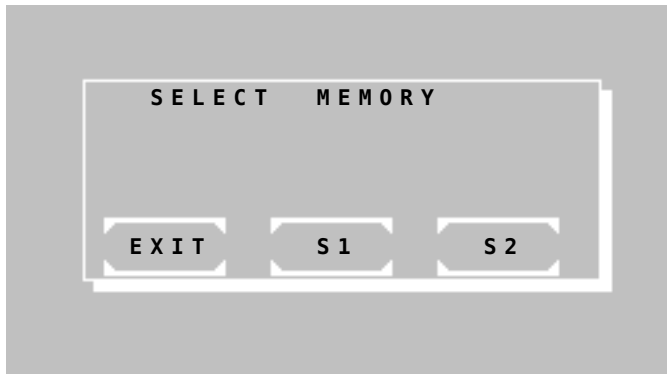

**7.2.6.2 DAILY MEMORY**

- [S1] Select daily memory for serum 1
- [S2] Select daily memory for serum 2
- [EXIT] Return to previous window

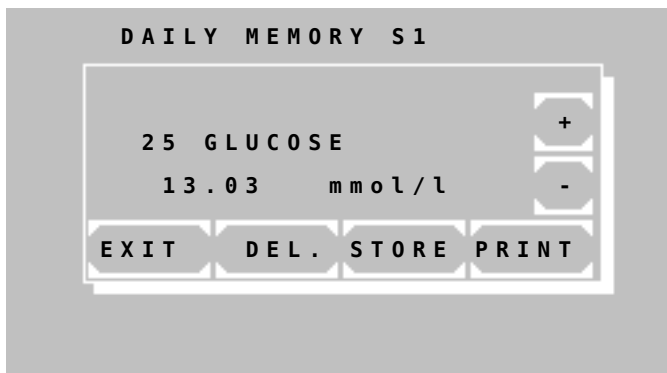

Measuring data of the corresponding daily memory are shown with method number, method name, reading and dimension.

- [+] Change to next reading
- [-] Change to previous reading
- [DEL] Delete shown reading in the daily memory and confirm again by [DEL]
- [STORE] Store shown reading in the monthly memory and confirm again by [STORE]. Afterwards the reading is deleted in the daily memory.
- [PRINT] Print all readings
- [EXIT] Return to QC menu

Print-out of daily memory for serum 1:

```
*** DAILY MEMORY ***S1 *
PHOTOMETER 5010 #30001
V9.Xa dd/mm/yy D
LAB.: RIELE BERLIN
```

```
DATE: 09/03/25
TIME: 08:44:12
```

```
25 GLUCOSE 13.03
21 HDL-C 367
27 UREA COL 197.2
29 CK-MB 1128.1
31 GOT 189.9
```

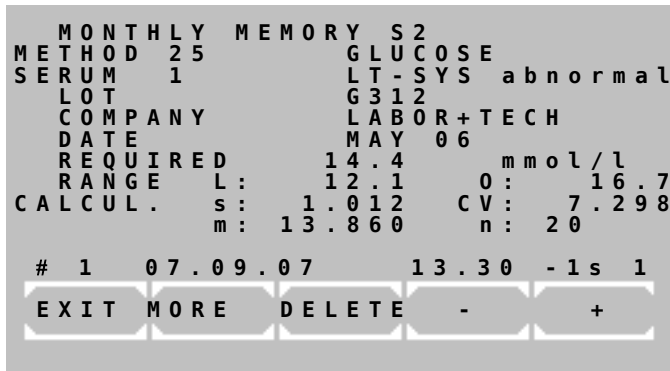
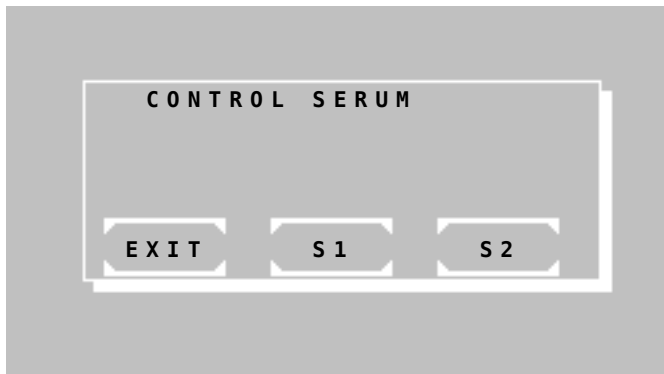

### 7.2.6.3 MONTHLY MEMORY

After query of method number select serum 1 or 2 of the method.

[S1] Select monthly memory for serum 1

[S2] Select monthly memory for serum 2

[EXIT] Return to previous window

In the overview window of the selected method all data of quality control are visible. In the line above the keys following information the current reading is indicated:

(# 1) → Numerator of the monthly memory. The oldest reading corresponds to the 1.

(01.27.06) → Date of reading

(13.30) → Reading

(-1.s) → Deviation of the reading lies within minus 1s. From +/-3s the warning level starts. With a deviation of > 3s an \* is displayed. For the calculation of the quality values of a method at least 20 readings in the month memory must be present!

(1) → User identification

The keys have following functions:

[+] Change to next reading

[-] Change to previous reading

[DEL] Delete all measuring data of the monthly memory of the selected method and confirm again (e.g. at change of serum)

[MORE] Change to output dialog

[EXIT] Return to QC menu

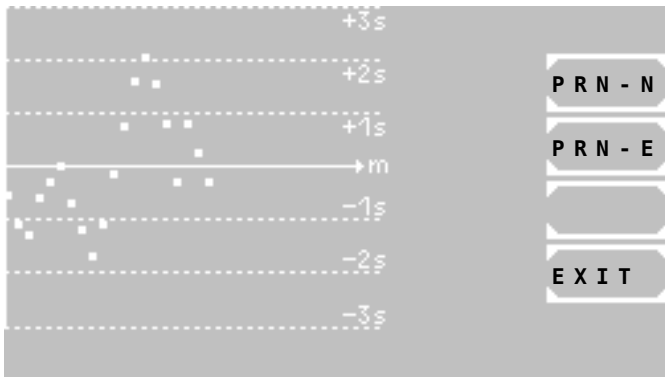

**Output dialog**

If at least 20 readings are stored in the monthly memory, these are indicated in the Levey Jennings plot. In this representation the deviations can be controlled visually and thus tendencies or systematic errors be better recognized.

The keys for the printout are located next to the curve diagram:

[PRN-N] Start the normal printout of the data of the current monthly memory. The single data of the readings are not printed thereby.

[PRN-E] Start the extended printout of the data of the current monthly memory. As shown in the example left, also the single data of the readings are printed.

[EXIT] Return to QC menu

Printout of the monthly memory of a method with serum 2:

```

** MONTHLY MEMORY **S2 *
DATE:          09/03/25
PHOTOMETER 5010 #30001
V9.Xa dd/mm/yy D
LAB.: RIELE BERLIN
METHOD 25: GLUCOSE
UNIT:          mmol/l
SERUM NO. 5
  ID   LT-SYS abnormal
  LOT   G312
  COMPANY LABOR+TECH
  DATE   MAY 11
  REQUIRED      14.4
  MIN.VALUE   12.1
  MAX.VALUE   16.7
QC VALUES   n: 20
MEAN         m: 13.860
STD.DEVIATION s: 1.012
COEFF.OF VAR CV: 7.298
    
```

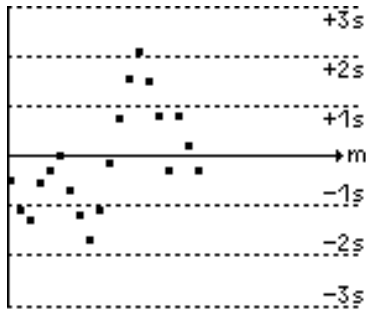

02/15/10	13.54	-1s	1
02/14/10	14.07	+1s	1
02/13/10	14.69	+1s	1
02/12/10	13.50	-1s	3
02/11/10	14.68	+1s	3
02/10/10	15.33	+2s	1
02/09/10	15.99	+3s	1
02/08/10	15.38	+2s	2
02/07/10	14.61	+1s	1
02/06/10	13.70	-1s	1
02/05/10	12.74	-2s	1
02/04/10	12.13	-2s	1
02/03/10	12.65	-2s	2
02/02/10	13.11	-1s	1
02/01/10	13.88	+1s	3
01/31/10	13.51	-1s	3
01/30/10	13.24	-1s	3
01/29/10	12.50	-2s	1
01/28/10	12.74	-2s	2
01/27/10	13.30	-1s	1

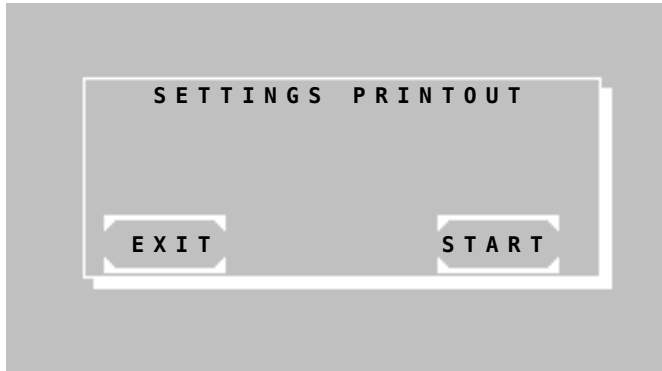
**Not implemented****7.2.7 Settings printout**

By [START] the program version and the complete status of the saved settings are printed out.

```

*****ACTUAL*SETS*****
DATE:          09/03/25
TIME:          08:44:12
PHOTOMETER 5010 #30001
V9.Xa dd/mm/yy D
/T5.3
CORE 124 V9.0
PCB LAYOUT          e
ADC COUNTS (DARK ADJ.)
N: 8394148  B: 8392514
FILTER
1: 340  2: 405  3: 492
21/21% 18/23% 12/18%
4: 546  5: 578  6: 623
13/20% 17/26% 16/24%
7: 999  8: 999  9: 999
0/ 0%  0/ 0%  0/ 0%
TEMPERATURE S
25C  11539
37C  14565
TEMPERTURE ADC RANGE
MIN.  200 MAX.  1500
PUMP
MS AIR          178
MS/50µl         56
PUMP SPEED (1-30) 25
B-DET.          6
VOLUME OPTIMIZED OFF
BATTERY:        OK
EDP ON          (CR-LF)
TOUCH
Mx148 My192 Fx120 Fy100
LANGUAGE
en fr
KEY SIGNAL ON
T.COUNTER :     334:45
S.COUNTER :     402
PROGR. METHODS  0
STORED RESULTS  123

```

N = Dark value without boost, B = Dark value with boost

The percentage is proportional to the brightness level.

The percentage value left represents the S-CUV system and the right one the FTC system.

### 7.2.8 Stored results

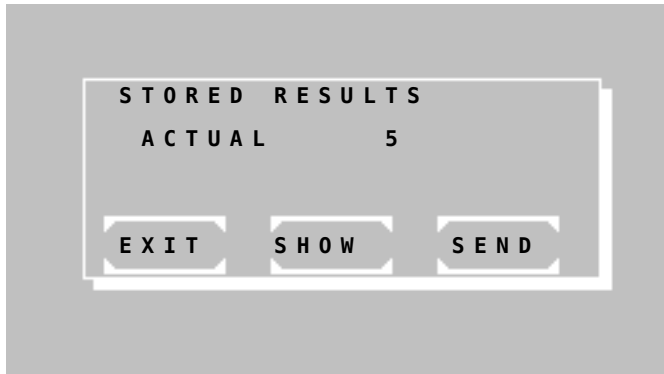

[EXIT] terminates the program.

[SHOW] indicates stored data step by step.

[SEND] transmits stored results through the serial port.

After transmitting is completed you will be prompted to delete stored results. Press [START] to delete results or [EXIT] to exit without deleting results.

### 7.2.9 Temperature ON / OFF

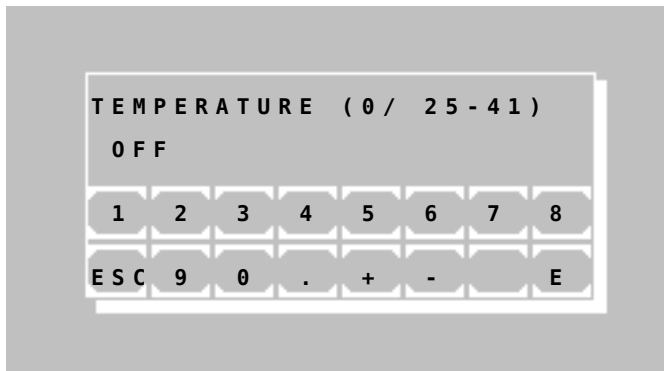

The temperature can be set in 1 °C steps between 25 °C - 41 °C.

0 °C is temperature OFF

Save setting permanently by [E].

[ESC] : finish input without storage

### 7.2.10 Temperature adjustment

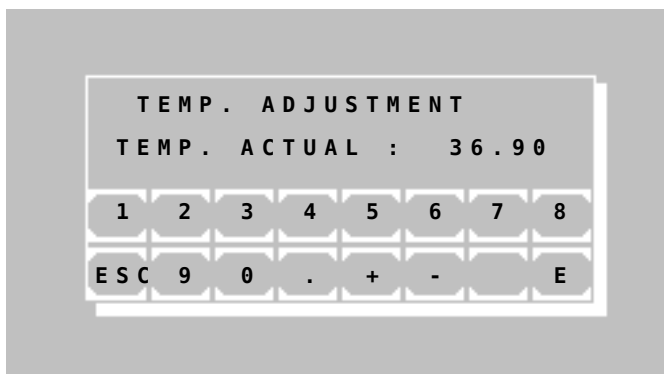

**The temperature control was adjusted at the factory!**

Anyhow the tempering control can be calibrated provided that the tempering was switched on for at least 30 minutes:

Measure the current temperature with an independent measuring system (e.g. thermistor, REF 090-063) inside the cuvette and enter this value. According to the difference to 25.0 °C, 30.0 °C or 37.0 °C the system corrects its internal setting. The calibrating of the temperature is interrupted when the tempering is off or the temperature unstable.

Enter the password "5010".

Enter the actual temperature in TEMP. ACTUAL four-digit in °C (e.g. 36.90) and confirm by [E].

### 7.2.11 Laboratory name

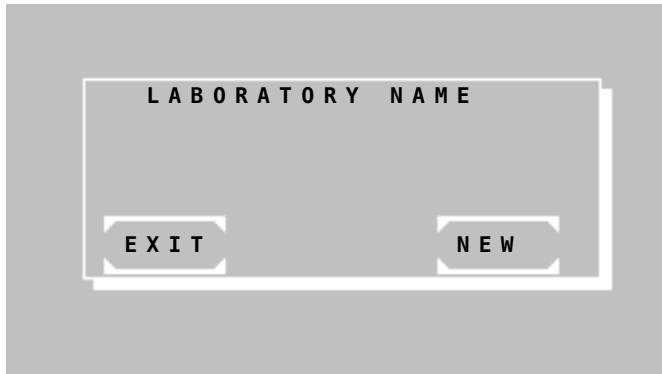

The name of the laboratory can be stored permanently.

In case of a stored name an additional line within the header is sent to the printer or to the EDP.

By [NEW] the entry of the laboratory name is possible.

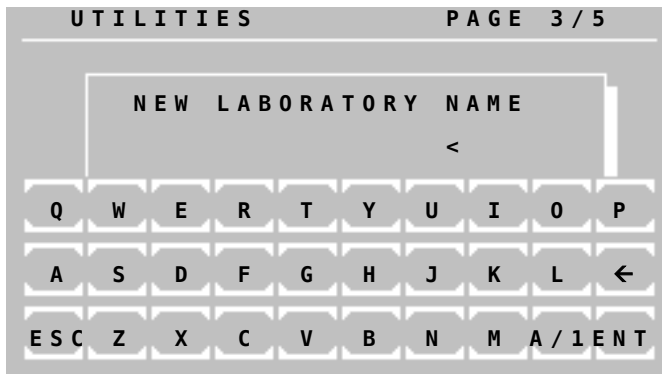

Enter the laboratory name via the alphanumeric keyboard.

Following functions are available:

- [a/1] : change to lowercase
- [1/A] : change to numeric characters
- [A/a] : change to uppercase
- [←] : delete character
- [→] : blank
- [ESC] : finish input without storage
- [ENT] : finish input with storage

### 7.2.12 User name

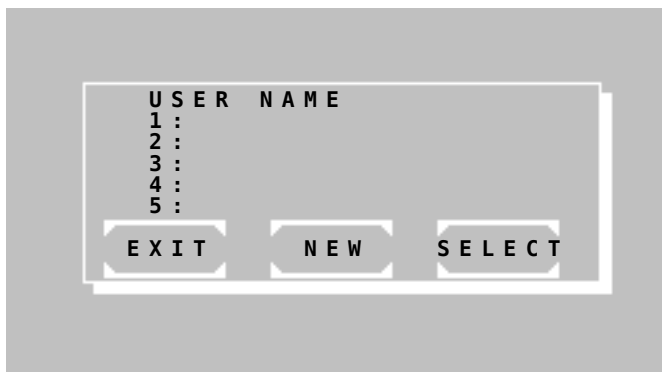

The names of maximum five users can be stored permanently.

After calling a method the user is queried.

In case of a stored name an additional line within the header is sent to the printer or to the EDP.

Select user by [SELECT]. By [NEW] the entry of the user name is possible.

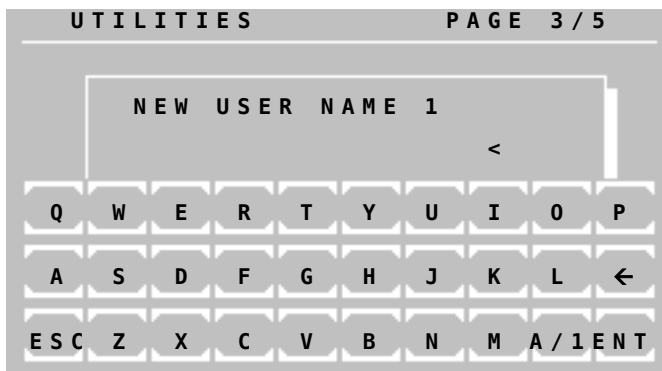

Enter the user name via the alphanumeric keyboard.

Following functions are available:

- [a/1] : change to lowercase
- [1/A] : change to numeric characters
- [A/a] : change to uppercase
- [←] : delete character
- [→] : blank
- [ESC] : finish input without storage
- [ENT] : finish input with storage

### 7.2.13 Error list

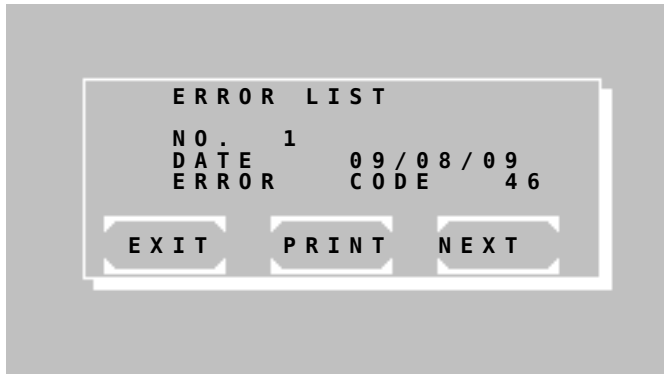

The last 10 serious errors are shown or printed.

The oldest error is shown first. The last error is always marked with no 1.

By [NEXT] earlier error messages are shown.

By [PRINT] the complete error list is printed or output to the serial interface.

For troubleshooting the coded error list can be consulted (chapter 9.4 - CODED ERROR MESSAGES).

### 7.2.14 Key signal ON / OFF

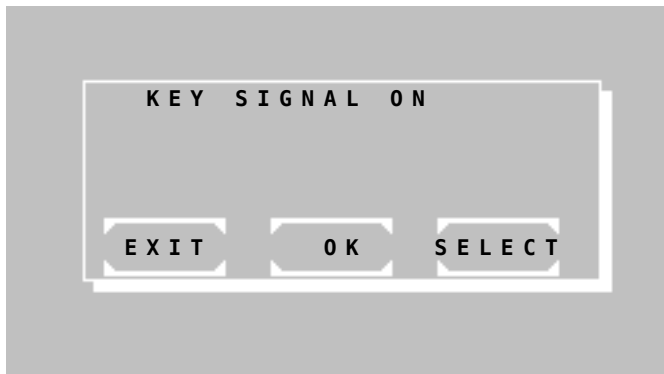

The current status of the key signal is indicated in the first line by OFF or ON.

Change setting by [SELECT].

Save setting permanently by [OK].

Save setting temporarily up to next switch-off of the device by [EXIT].

The deeper signal tone for error messages remains active in any case.

### 7.2.15 Touchscreen adjustment

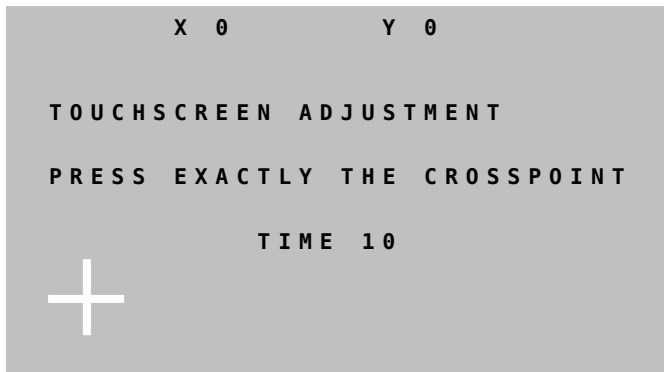

By this function the touchscreen can be adjusted. After call of the function a white cross is shown in the left lower corner of the screen. Touch the intersection point in the cross with a non-scratching plastic tip (touchscreen pen, pipette tip) as exactly as possible. In the first line the coordinates are shown as X- and Y-value. The input will be accepted and the coordinate display will be reset after a time out of 10s. Then the cross is shown in the right upper corner. Touch the intersection point. After a timeout of 10s the memory inquiry follows.

Save the adjustment by [OK].

Reject the adjustment by [EXIT].

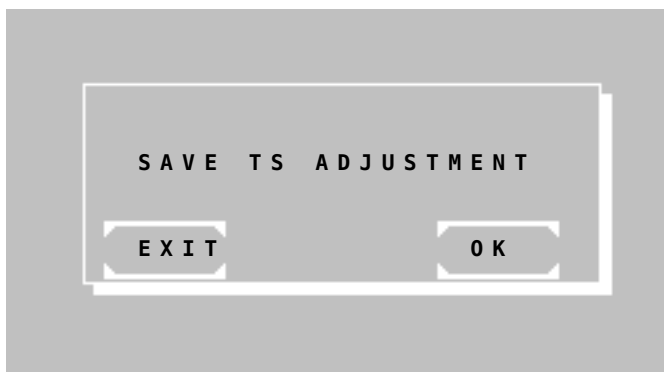



**Hint:** If the device is maladjusted, this function can directly be called during the switching on routine:

Switch on the device. After greeting screen (chapter 2.3 - INSTALLATION) is displayed, keep the touchscreen or the zipping lever [P] pressed. After some seconds a deep signal tone sounds and the text message "TOUCHSCREEN ADJUSTMENT" will be shown at the first line of the greeting screen. Release the touchscreen within one second. Execute the adjustment of the touchscreen as described above. Select the type of photometer after touchscreen adjustment is completed.

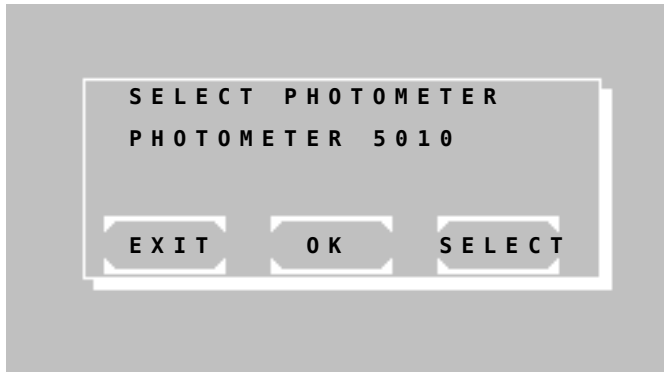

Select type of photometer:

Reject setting by [EXIT].

Save setting permanently by [OK].

With [SELECT] the type of photometer is selected.

### 7.2.16 Date / Time

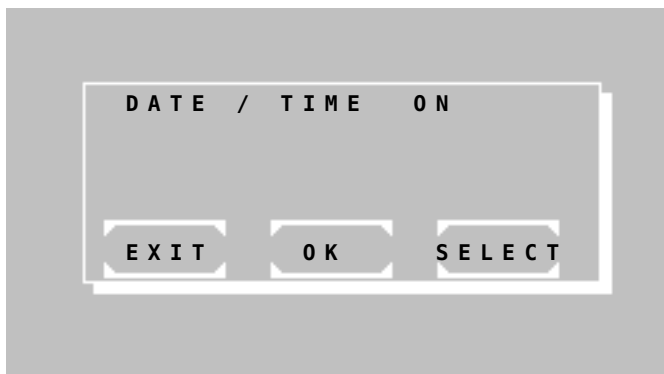

The status of the date/time display is indicated in the first line by OFF or ON.

Change setting by [SELECT].

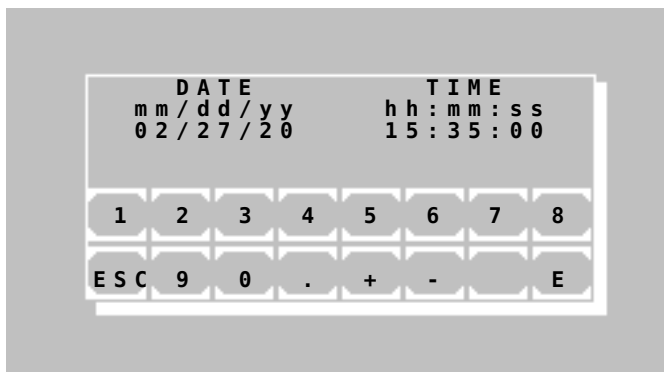

With activation of the clock date and time can be changed by [OK]. Each entry of day, month, year, minute and second must be confirmed by [E].

**i** If a value is to be changed, then all values must be entered again!

NO.	ABS.	RESULT
1	0.675	19.8
TIME:		11:21:32

**i** When printer ON via [MODE] [PRN] after a measurement the current time can be printed out by [TIME].

### 7.2.17 Language



The status of the language is indicated in the first line.

The setting can be changed by [SELECT] Following options are possible:

- LANGUAGE : ENGLISH
- LANGUAGE : GERMAN

Save setting permanently by [OK].

The setting is temporarily saved up to next switch-off of the device by [EXIT].

With LANGUAGE 6 DOWNLOAD, three additional languages can be added with [OK] using the download program.

If you select START DOWNLOAD [YES], all the old languages 3 – 5 are deleted and exchanged with the new set of languages.

### 7.2.18 ADC counts (Optic)

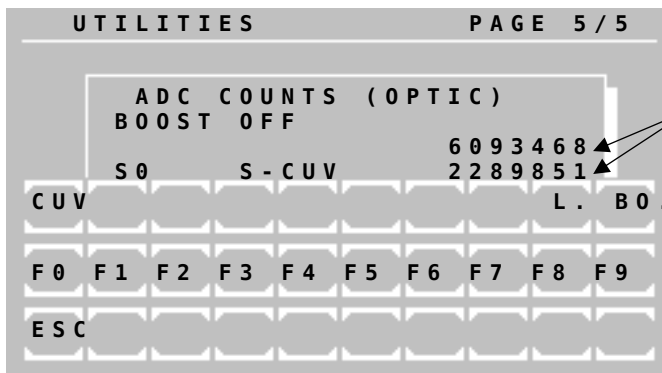

**The routine assists the technician in controlling the measuring system.**

Indicated are the current values of the optical analogue-digital converter (ADC). Both values are proportional to the light-current depending on special settings of the ADC.

To a key actuation the system reacts possibly with a time lag of ca. three seconds.

The function [BO.] increases the sensitivity of the ADC.

The function [F0] upto [F9] places the filter wheel into the positions 0 upto 9. The position 0 corresponds to the dark position of the filter wheel.

The function [CUV] changes the cuvette system to S-CUV or FTC.

The function [L.] switches the LED off and on.

Stop function by [ESC].

### 7.2.19 Bar Code

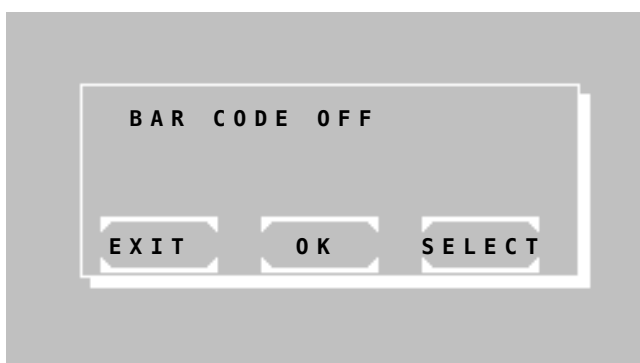

The status of the bar code is indicated in the first line.

The bar code reader can be activated by changing the setting by [SELECT].

The settings of the barcode reader must be set to: RS232, CR/LF, XON/XOFF, 19200 baudrate, 8 Bit, 1 Stopbit, no parity, XON/XOFF setting.

When a bar code is inserted it is displayed instead of an ID-NO on the display, printout and in the stored results.

Stop function by [EXIT].



**Description:**

A bar code like the left one can be scanned. The number of scanned characters is limited upto 15. Alphanumerical characters are allowed.

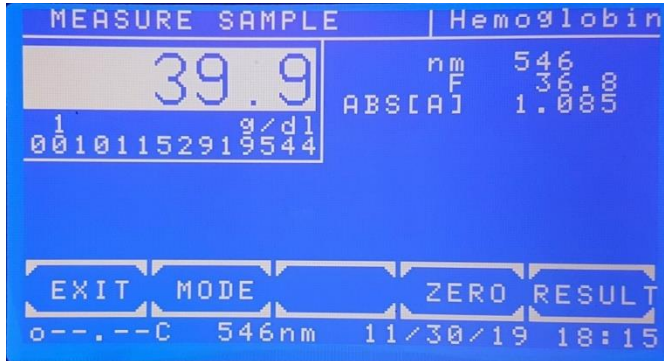

The scanned barcode will be shown before and after a measurement below the result.

The number of scanned characters is limited upto 14. 15 characters are stored in the memory.

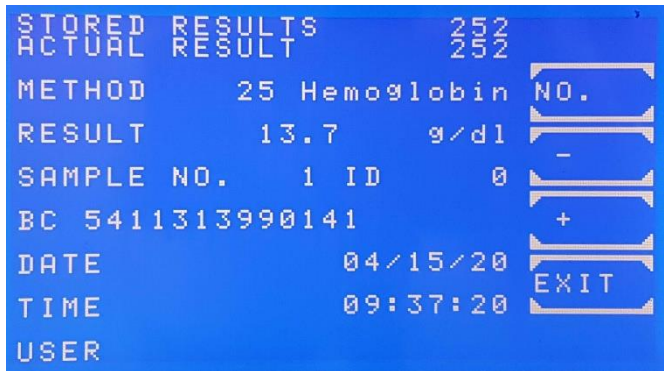

While using the function chapter 7.2.8 - Stored results the scanned barcode is shown in the line BC.

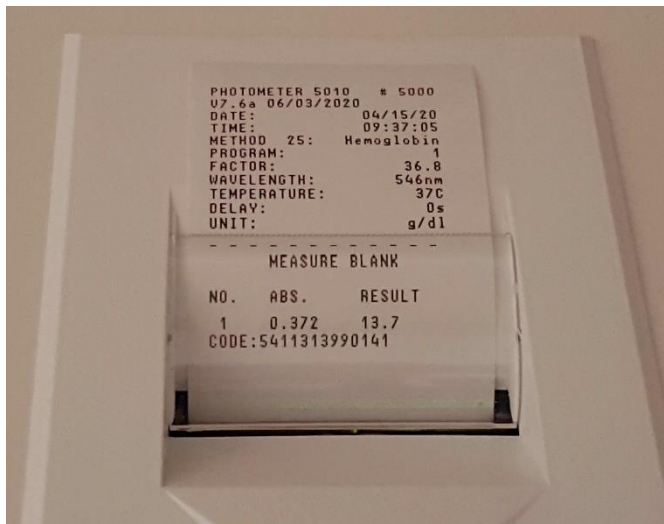

In case of not using a bar code reader but an activated function BAR CODE ON instead of a scanned bar code a generated code will be shown:

The most significant characters are representing the date: etc. 191207 (Dec 7<sup>th</sup>, 2019)

The following characters are representing a numerator: etc. 0000001

### 7.2.20 Service tools

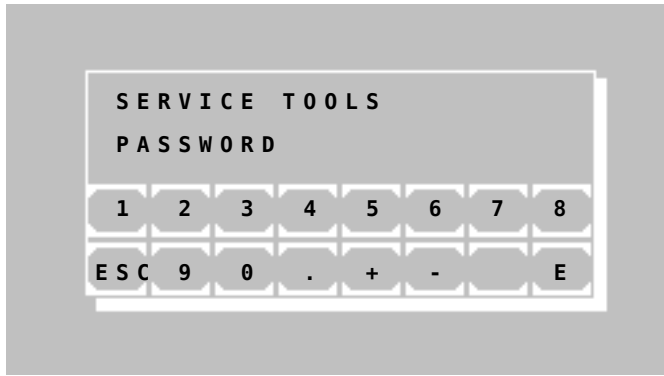

The service tools are reserved for trained specialists only and therefore protected by a password.

Stop function by [ESC].

## 8 MAINTENANCE

This chapter provides necessary information concerning general maintenance by the user.



If any faults should occur which cannot be remedied, then service should be contacted. Repairs at the device may be carried out only by authorized specialist staff. Through improper repairs the warranty extinguishes, and the user can be heavily jeopardized.

### 8.1 CLEANING INSTRUCTION



Liquid waste is potentially biologically hazardous. Always wear gloves if handling those materials. Do not touch parts of the device other than those specified. Consult the laboratory protocol for handling biohazardous materials.



Take care that no liquid enters the device! There is no protection against penetrating of liquids (Code IP X0). Check from time to time that the tubing and the connections are leakproof.

The **flow-through system** of the Photometer 5010 has to be washed with dist. water regularly before and after measuring 2 – 3 times. Depending on sample material and reagent, and **always** at the end of a working day, the Photometer 5010 has to be cleaned additionally with a phosphate-free detergent, e.g. with approx. 5ml of Biogent-A (REF 5010-024), and afterwards rinsed with 5ml distilled water.

Persistent residues are to be removed with a combined alkaline-acid treatment. The following procedure is advised step by step:

1. 5 x wash with NaOH 1 N
2. 5 x rinse with dist. water
3. 5 x wash with HCl 0.5 N
4. 5 x rinse with dist. water

If the system is contaminated severely, it may alternatively be cleaned with hypochlorite. The following procedure is advised step by step:

1. 5 x rinse with dist. water
2. 2 – 3 x wash with hypochlorite (1:20 diluted solution) or ISE Cleaning Solution, undiluted, let it possibly affect up to 20 minutes
3. 5-10 x rinse with dist. water

For device cleaning and surface decontamination purposes use commercial decontaminating solution which are usually available in clinical chemistry laboratories like Mikroziid® AF Liquid, BacilloI® plus, 3 % Kohrsolin® or similar solutions. Switch off the device and disconnect it from the mains voltage. Then clean the device with soft cloth and decontaminating solution.

Empty the drain tank at the end of daily measurement, or whenever filled.

### 8.2 CALIBRATING MEASURING SYSTEM

At doubtful measurement results an optic adjustment has to be carried out corresponding to chapter 7.2.1.

### 8.3 ADJUSTMENT OF BUBBLE DETECTOR

See chapter 7.2.4 - Pump

### 8.4 CALIBRATION OF PERISTALTIC PUMP

See chapter 7.2.4 - Pump

### 8.5 REPLACEMENT OF PAPER ROLL

See chapter 2.4 - LOADING PRINTER PAPER

## 8.6 REPLACEMENT OF ASPIRATION TUBE

When replacing the aspiration tube pay attention to the sequence of the assembly parts as shown below. Then put aspiration tube without bending from the cuvette area side through the metal inlet tube. Turn screw connection with fingers into the cuvette.

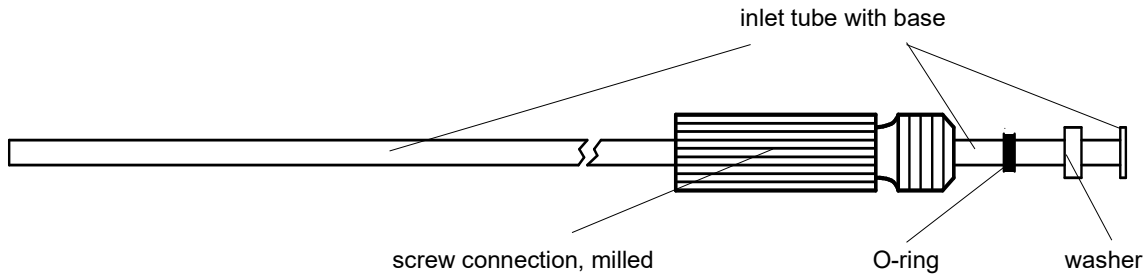

## 8.7 REPLACEMENT OF LINE FUSES

The Photometer 5010 operates at any line voltage between 100 V<sub>AC</sub> and 240 V<sub>AC</sub> at 50/60 Hz without adjustment. The power inlet socket has a fuse holder with a fuse with following specifications.



**Neither use makeshift fuses nor short-circuit the fuse holder!**

Specifications of the fuse:

- dimensions [mm] : 5 \* 20
- standard: EN 60127-2-2
- time-current characteristic: quick-acting F
- voltage rating: 250 V~
- rated current: 6.3 A
- marking: 6.3 A F

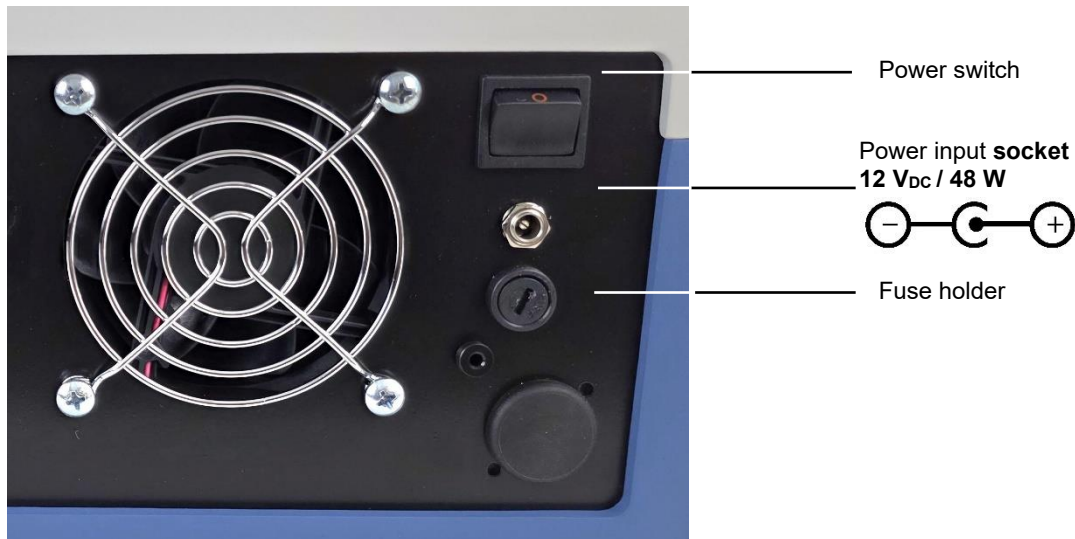

## 9 ERROR MESSAGE / CORRECTION

### 9.1 GENERAL NOTE

Faulty input (e.g. wrong method number or wrong factor), recognized by the user, can be corrected by filling up the respective entry field with any signs. After replenishing beyond the last position the faulty input is deleted and the entry field is free again for the renewed correct input.

Error messages by the device are carried out either exclusively via a signal tone (chapter 9.2 - ACOUSTIC ERROR MESSAGES) or as combination signal tone and display.

In the display errors are shown as plaintext (chapter 9.3 - PLAINTEXT ERROR MESSAGES)

... or coded with an error number (chapter 9.4 - CODED ERROR MESSAGES).

Each error message has always to be confirmed with [E].

### 9.2 ACOUSTIC ERROR MESSAGES

When pressing a key which is not permitted or not meaningful a deeper signal tone still sounds as error message after the higher signal tone (which is to confirm the keystroke, can be switched off according to chapter 7.2.14 - Key signal ON / OFF). In the display no corresponding error message appears parallel to this. The operation of the device can directly be continued by the correct keyboard entry.

### 9.3 PLAINTEXT ERROR MESSAGES

RANGE MIN.	The programmed low limit was under-run by the measurement.
RANGE MAX.	The programmed upper limit was exceeded by the measurement.
NON-LINEAR	The square of the correlation coefficient R lies at the kinetic measuring below the programmed low limit.
RANGE +/-	At the kinetic measuring the procedure of the kinetic is wrong (increasing / falling).
NO METHOD	Dialed method is not programmed. Select other method according to method list.
HEATING OFF	Heating / cooling is off during temperature calibration.
TEMP. UNSTABLE	Temperature is unstable during temperature calibration.

## 9.4 CODED ERROR MESSAGES

No.	(possible) Causes	Remedy
1	method is write protected, method cannot be cleared	by special software
2	check sum of a freely programmed method is wrong	program new method
3	forbidden input, wrong number format	repeat input in permitted area
4	method not available	method editor: check method no.
5	dark value is absolutely too high (> 16 bit) or higher as the measurement, ADC overflow	repeat optic adjustment (chapter 7.2.1); check LED / filter; check blank
6	all multiplexer positions are too bright/too dark at setting to zero	repeat optic adjustment (chapter 7.2.1); check filter / LED; check blank
7	mathematical overflow, at measurement calculation	check filter; check standard; check measuring solution
8	check sum error in the data record of the dark offset	repeat optic adjustment (chapter 7.2.1)
9	check sum error in the data record of the device basic setting (status, ADC correction)	automatic error remedy
10	division by a too small value (< 0.001 A)	check filter; check standard; check measuring solution
11	invalid calibration curve	Select valid number
12	setting to zero not possible (zero value is < 32768 cycle)	check LED; check filter; check zero solution
13	setting to zero not possible (zero value is > 983039 cycle)	repeat optic adjustment (chapter 7.2.1); check LED; check filter; check zero solution
14	invalid standard	measure valid standard solution
15	no parameter memory vacant (too little memory for <u>non-linear</u> methods)	delete a no longer actual <u>nonlinear</u> method
16	method no. is occupied	select other method no.; delete a no longer actual <u>nonlinear</u> method
17	check sum error in the parameter memory ( <u>nonlinear</u> method)	program method newly
18	at calculation overflows in <u>nonlinear</u> method	check factor; check parameter
19	clock malfunction	
20	overflow at Kinetic	check measuring solution
21	overflow at Kinetic	check measuring solution
22	overflow at Kinetic	check measuring solution
23	overflow at Kinetic	check measuring solution
24	overflow at Kinetic	check measuring solution
25	overflow at Kinetic	check measuring solution
26	overflow at Kinetic	check measuring solution
27	overflow at Kinetic	check measuring solution
28	overflow at Kinetic	check measuring solution
29	wrong input of deltas or time per delta	restart method
30	battery empty	contact service partner
31	communication: wrong data format	contact service partner
32	communication: sent data not plausible / not interpretable	contact service partner

33	communication: mentioned module does not answer in a certain time	check interconnecting cable; check mentioned module
34	communication: overflow send/receive buffer	reduce amount of data at the communication partner
35	remote control: wrong method number	external software problem
36	remote control: unknown command	external software problem
37	remote control: wrong data format	external software problem
38	check sum of operating system bank 0 damaged	contact service partner
39	check sum of operating system bank 1 damaged	contact service partner
40	timeout at reception from module 2	switch off/on device
41	check sum error at reception from module 2	switch off/on device
42	NAK at reception from module 2	switch off/on device
44	error at pump calibration - pump tube not clamped; - no liquid aspirated; - too much liquid aspirated during calibrating; - power of the pump too small; - motor does not rotate or stops; - connectors of tubes leaky; - bubble detector works falsely; - aspiration tube blocked; - aspiration tube badly stained	- clamp pump tube; - control volume of aspiration; - control connectors of tubes; - the plug of the bubble detector has a bad contact; - the cable of the bubble detector has a bad contact; - adjust bubble detector (chapter 7.2.4); - replace aspiration tube (chapter 8.6)
45	error at sipping solution - pump tube not clamped; - no liquid aspirated; - power of the pump too small; - motor does not rotate or stops; - connectors of tubes leaky; - bubble detector works falsely; - aspiration tube blocked; - aspiration tube badly stained	- clamp pump tube; - adjust bubble detector (chapter 7.2.4); - control volume of aspiration; - control connectors of tubes; - do a calibration of peristaltic pump (chapter 7.2.4); - the plug of the bubble detector has a bad contact; - the cable of the bubble detector has a bad contact; - replace aspiration tube (chapter 8.6)
46	filter position out of tolerance	contact service partner
52	timeout printer internal	the internal printer is temporarily disconnected
53	Set of data points is missing	check multi-standard functions
55	number of given data points < 2	add data points
56	pump calibration not successful	repeat pump calibration using exactly 1000 µl (chapter 7.2.4)
59	error in the automatic measuring operation (remote)	check interface
60	error at multiplexer of operational amplifier	contact service partner
61	error at multiplexer of bubble detector	contact service partner
62	free method number not found	check method memory
63	wrong address at multi-standard loading	check multi-standards
64	current method not found in monthly memory	check QC data of method
65	more than 50 QC methods defined	delete unused QC methods
66	internal clock is off. QC data not storable	switch on internal clock
67	BCC error in dataset of QC method values	check current method
68	free monthly memory not found at QC	delete unused QC methods
69	free space in daily memory not found at QC	empty QC daily memory

70	error at QC calculation	check QC data
71	QC serum not found	check QC data
72	wrong address at saving test results	send results through serial interface and delete results (chapter 7.2.8)
73	results memory full, it will be overwritten	overwrite results memory or send and delete results (chapter 7.2.8)
74	BCC error at sending result string	send results through serial interface and delete results (chapter 7.2.8)
87	Concentration too low	Check sample
88	Concentration too high	Check sample
90	At startup error in the text area	Languages 3 - 5 are deleted
91	Temperature out of range	contact service partner

## 10 TECHNICAL DATA

### 10.1 ENVIRONMENTAL CONDITIONS

Climatic conditions for storage and transport of the packed device:

- Temperature: -25 °C to +70 °C
- Relative humidity: 20 % to 85 %
- 

The Photometer 5010 must be used in an environment that meets the following conditions:

- Temperature: +15 °C to +35 °C
- Relative humidity: 20 % to 85 %
- Not exposed to direct sunlight or other source of direct light (e.g. a spot light)
- Well-ventilated area
- Free from excessive dust
- Free from combustible gases
- Free from vibrations
- Free from electromagnetic wave interference
- Well-distanced from a machine generating a high frequency high voltage (e.g. a centrifuge)

### 10.2 MINIMAL OPERATION QUALITY



Signal processing in analogue amplifiers with high amplification factors cannot differentiate desired from undesired signals. Amplifiers thus are apt to be overloaded or produce spurious signals. The equipment will operate correctly when the undesired signals are removed. Short-term changes of the operational behavior do not influence the overall function of the device.

### 10.3 TYPE PLATE

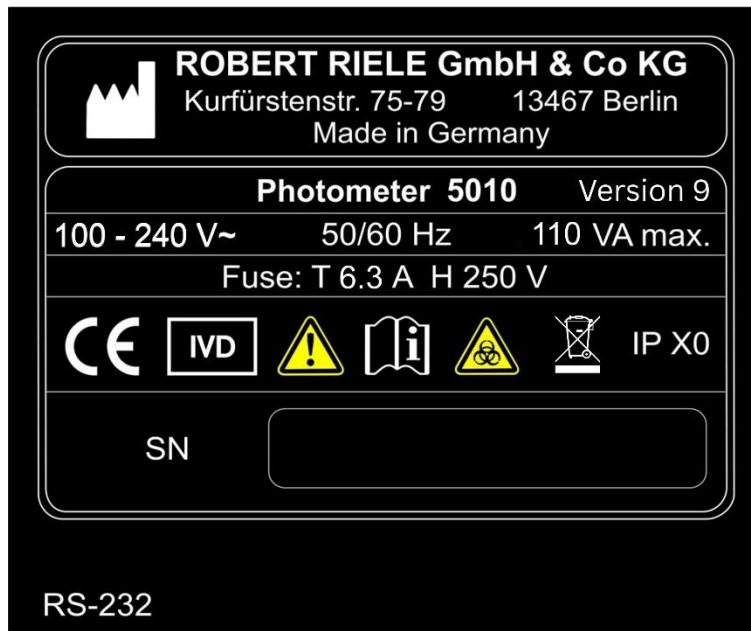
For installation pay attention to the specifications on the type plate.



**10.4 SHORT SPECIFICATIONS**

<b>Type</b>	Semi-automatic, single-beam filter photometer
<b>Light Source</b>	LED with long lifetime
<b>Wavelength</b>	340 nm and 390 nm – 730 nm
<b>Wavelength Selection</b>	Automatic via 9-position filter wheel : 6 standard interference filters: 340 nm, 405 nm, 492 nm, 546 nm, 578 nm and 623 nm; 3 positions for optional filter of choice
<b>Photometric Range</b>	0.0 – 3.0 A
<b>Cuvette System</b>	Micro flow cell:32 µl, 10 mm light path interchangeable with normal standard cuvettes (macro or semi-micro, disposable or special optical glass)
<b>Temperature Control</b>	<ul style="list-style-type: none"> <li>▪ Internal Peltier element, temperature variable, programmable in 1°C steps between 25°C - 41°C</li> <li>▪ Equilibration time for aspirated reaction mixture to reach 37 °C from ambient temperature: 15 s</li> </ul>
<b>Aspiration System</b>	Built-in peristaltic pump driven by stepper motor, programmable aspiration volume controlled by infrared light barrier
<b>Sipping Volume</b>	<ul style="list-style-type: none"> <li>▪ Minimum 250 µl, typically 500 µl up to 2000 µl</li> <li>▪ Separate setting of aspirate volume and wash volume</li> </ul>
<b>Operator Interface</b>	Touchscreen for direct functions and alphanumeric inputs
<b>Data Presentation</b>	Graphic display: White characters or symbols, blue background, lighted, resolution 240 * 128 dots
<b>Integrated Printer</b>	Thermal printer
<b>Languages</b>	English and French/German/Indonesian/Russian/Spanish/Polish
<b>Memory</b>	<ul style="list-style-type: none"> <li>▪ General operating software can be updated by PC</li> <li>▪ Reagent-open system with capacity for up to 231 programmable methods</li> <li>▪ Data import by touchscreen or PC</li> <li>▪ Up to 50 nonlinear calibration curves with max 20 sets of points can be stored</li> </ul>
<b>Signal Port</b>	Serial port for connection to an external printer and/or PC
<b>Data Logging</b>	Up to 1000 results can be saved in the memory automatically
<b>Measurement Procedures</b>	<ul style="list-style-type: none"> <li>▪ Absorbance</li> <li>▪ End point with factor, standard or multiple standards, with or without reagent blank and/or sample blank</li> <li>▪ Bichromatic end point</li> <li>▪ Kinetics with factor, standard or multiple standards, with or without blank</li> <li>▪ Fixed time with factor, standard or multiple standards, with or without reagent blank</li> <li>▪ Turbidimetry with optional timer function</li> <li>▪ Single, double and triple determinations</li> <li>▪ Curve fitting for nonlinear standard curves</li> <li>▪ Free hemoglobin in combination with optional interference filters</li> </ul>
<b>Quality Control</b>	Up to 50 methods can be controlled with two control serums, Levey Jennings plot
<b>Measuring Time</b>	<ul style="list-style-type: none"> <li>▪ Kinetic: variable from 3 – 19 deltas, time per delta 3 – 255 s</li> <li>▪ Fixed time: variable from 0 – 1800 s</li> </ul>
<b>Delay Time</b>	Programmable from 0 – 1800 s
<b>Power Supply</b>	Input voltage: 12 V <sub>DC</sub> • Universal external power supply Range: 100 V <sub>AC</sub> up to 240 V <sub>AC</sub> at 50/60 Hz optional: power bank, solar panel, vehicle power supply
<b>Dimensions</b>	Length 33 cm x width 34 cm x height 18 cm
<b>Weight</b>	5.0 kg
<b>Marking</b>	 

## 10.5 TECHNICAL SPECIFICATIONS

<b>A Identification</b>		
A.1	Type of photometer:	Photometer 5010
A.2	Model:	5010
A.3	Basis-UDI-DI:	426237161P5010V5+S2
A.4	Instruction for use:	Photometer 5010, user manual
A.5	Manufacturer	ROBERT RIELE GmbH & Co KG Kurfuerstenstrasse 75-79 D-13467 Berlin Germany

### DECLARATION OF CONFORMITY:

The above mentioned absorption photometer is in conformity with the following metrological description.

Berlin, January 2026

ROBERT RIELE GmbH & Co KG



Dr. Linda Riele



Lorenz Riele

<b>B Metrological description</b>		
<b>B.1 <u>Measuring System</u></b>		
B.1.1	Optical configuration:	cf. Figure
B.1.2	Source[s] of radiation:	LED
B.1.3	Spectroscopic apparatus:	filter wheel
B.1.4	Radiation detector[s]:	photodiode
B.1.5	Cuvette[s]/cell[s]:	10 mm glass or plastic cuvette (square shaped) or 10 mm flow-through cuvette
B.1.6	Temperature regulation of the cuvette:	25 °C to 41 °C in 1 °C steps
B.1.7	Displayed units:	absorbance, mass concentration, enzyme activity
B.1.8	Display device:	digital display, absorbance: 0.000 to 3.000 mass concentration: 0.000 to 9999 enzyme activity: 0.000 to 9999
<b>B.2 <u>Method of measurement</u></b>		
B.2.1	Generation of spectral absorbance $A(\lambda)$	monochromatic measurement
B.2.2	Zero compensation of spectral absorbance	manual
B.2.3	Control of the measured spectral absorbance:	with an absorption reference solution (see manual)
B.2.4	Determination[s] of concentration:	Lambert-Beer-Equation

**B.3 Specified measuring range**

Outside the specified measuring range and under rated operating conditions other than those stated in section B.4, the maximum permissible errors given in section B.5 can be exceeded.

B.3.1	Spectral absorbance $A(\lambda)$ :	0.0 A to 3.0 A
B.3.2	Wavelength $\lambda$ useable for measurements:	340 nm and 390 nm to 730 nm

**B.4 Specified Operation conditions**

B.4.1	Spectral transmittance of the cuvette:	> 75 %
B.4.2	Warm-up time:	15 min
B.4.3	Operating voltage [mains]:	between 100 V <sub>AC</sub> and 240 V <sub>AC</sub> at 50/60 Hz with a tolerance of 10 %
B.4.4	Ambient temperature:	15 °C to 35 °C
B.4.5	Sound pressure level SPL	< 50 dB

**B.5 Maximum permissible errors and other limiting values**

B.5.1	Photometric uncertainty of the spectral absorbance:	0.2 < A ≤ 0.5 → ± 10 digit A > 0.5 → ± 3 %
B.5.2	Photometric short-time variation coefficient:	≤ 1 %
B.5.3	Uncertainty of wavelengths:	max ± 2 nm
B.5.4	Spectral half-width of spectral radiation flux at detector:	≤ 10 nm
B.5.5	Percentage of wavelength integrated false radiation ( measured at 340 nm as transmittance of a cut-off filter NaNO <sub>3</sub> ):	≤ 0.1 %
B.5.6	Uncertainty of temperature regulation:	≤ 0.2 °C
B.5.7	Specimen related carry-over ratio: measure according to Broughton with p-Nitro phenol	≤ 1 %

**OPTIC CONSTRUCTION**

The optical path is directed from left to right of the device. Insert standard cuvette accordingly.

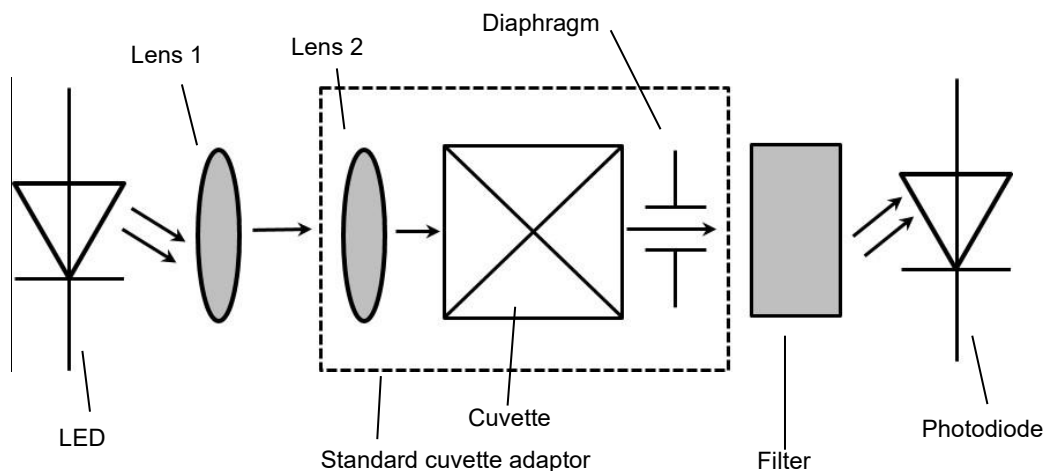

## 11 ACCESSORIES AND SPARE PARTS

Kindly contact directly the responsible dealer.

REF	Description
5010-065	Aspiration tubing 185 mm, 2 pcs
5010-024	Biogent-A, 1000 ml
1706870001	Bubble detector with plug
573655001	Cuvettes of optical glass, 4 pcs
501-002	Data cable serial interface
5010-216	Discrete flow through cuvette
805-410	Disposable cuvettes, 1000 pcs
1704818001	Dust cover
5010-018	Fuses for line power, 10 pcs
500-002	Incubator T12
500-001	Incubator T16
1707175001	Joint inlet tube cuvette
5010-005	Operator's manual
5010-066	Outlet tube cuvette, 5 pcs
5010-212	Power bank
090073	Thermal printer paper, 5 rolls
090075	Thermal printer paper, permanent 10 years, 5 rolls
5010-050	Pump tube with joints
090-064	Secondary calibration standards, four-piece, certified
5010-202	Standard cuvette adaptor V7
1707574001	Top cover small for printer
1704834001	Waste tubing, 2 pcs



**Incubator T12**



**Incubator T16**

## 12 METHOD LIST

- 1 - 16.....16 basic methods (chapter 12.1 - BASIC METHOD)  
 17 - 19.....free (reserved for further 3 automatic calculation methods)  
 20 - 250.....up to 231 user specific methods (chapter 12.2 - LIST OF USER SPECIFIC METHODS as copy master / to be filled out by the user)

### 12.1 BASIC METHODS

No.	Method Name	Dim	Volume	CP	Characteristic	$\lambda$ [nm]	Factor Standard	Delay Incubation [s]	Kinetic T1 Reaction [s]	Tempering	Min.r <sup>2</sup>	Min.Units	Max.Units
1	C/F			1	C/F								
2	C/F/Rb			2	C/F/Rb								
3	C/F/Sb			3	C/F/Sb								
4	C/F/SbRb			4	C/F/SbRb								
5	C/S			5	C/S								
6	C/S/Rb			6	C/S/Rb								
7	C/S/Sb			7	C/S/Sb								
8	C/S/SbRb			8	C/S/SbRb								
9	FTK/F/Rb			9	FTK/F/Rb								
10	FTK/S/Rb			10	FTK/S/Rb								
11	KIN/F/Rb			11	KIN/F/Rb								
12	KIN/S/Rb			12	KIN/S/Rb								
13	TRANSM.	%		13	TRANSM.								
14	C/F DELTA			14	C/F DELTA								
15	C/F 3 WL			15	C/F 3 WL								

No.	Method Name	Dim	Volume	CP	Characteristic	$\lambda$ [nm]	Factor Standard	Delay Incubation [s]	Kinetic T1 Reaction [s]	Tempering	Min. $r^2$	Min.Units	Max.Units
1	C/F			1	C/F								
2	C/F/Rb			2	C/F/Rb								
3	C/F/Sb			3	C/F/Sb								
4	C/F/Sb/Rb			4	C/F/Sb/Rb								
5	C/S			5	C/S								
6	C/S/Rb			6	C/S/Rb								
7	C/S/Sb			7	C/S/Sb								
8	C/S/Sb/Rb			8	C/S/Sb/Rb								
9	FTK/F/Rb			9	FTK/F/Rb								
10	FTK/S/Rb			10	FTK/S/Rb								
11	KIN/F/Rb			11	KIN/F/Rb								
12	KIN/S/Rb			12	KIN/S/Rb								
13	TRANSM.	%		13	TRANSM.								
14	C/F DELTA			14	C/F DELTA								
15	C/F 3 WL			15	C/F 3 WL								



